

BHEL REF NO. D5A1X20339

**Annexure - A
(Technical terms and Material Specification)**

Lot No	SI No.	Material Code.	Description	Qty	Technical terms and Material specification	Vendor's confirmation
LOT 1	1	HE9712454533	TITANIUM NOZZLE FLANGE FORGING	4	MATERIAL SHALL BE AS PER FOLLOWING i) ASME CODE 2021 EDITION TO BE FOLLOWED WHEREVER EDITION IS MENTIONED IN DRAWING. ii) ALL CLAUSES OF THE Drg.4-16010-09716 REV.00 ARE TO BE STRICTLY ADHERED TO. iii) 100% INSPECTION AND CERTIFICATION BY M/S BHEL APPROVED TPIA FOR INDIAN SUPPLIERS. iv) FOREIGN SUPPLIERS CAN APPOINT ANY ONE OF THE BHEL APPROVED TPIA NAMELY M/s DNV, M/s LLOYDS, M/s BV, M/s TUV. v) ITEM SHALL NOT BE MANUFACTURED FROM MELTED OUT SCRAP TITANIUM MATERIAL.	
LOT 2	2	HE9712454541	DRAIN CONN.BLIND FLANGE (SB-381 GR.F3)	4	MATERIAL SHALL BE AS PER FOLLOWING, i) ASME CODE 2021 EDITION TO BE FOLLOWED WHEREVER EDITION IS MENTIONED IN DRAWING.ALL CLAUSES OF THE Drg.4-16010-09718 REV.00 ARE TO BE STRICTLY ADHERED TO. ii) 100% INSPECTION AND CERTIFICATION BY M/S BHEL APPROVED TPIA FOR INDIAN SUPPLIERS. iii) FOREIGN SUPPLIERS CAN APPOINT ANY ONE OF THE BHEL APPROVED TPIA NAMELY M/s DNV, M/s LLOYDS, M/s BV, M/s TUV iv) ITEM SHALL NOT BE MANUFACTURED FROM MELTED OUT SCRAP TITANIUM MATERIAL.	
	3	HE9715004962	4" DRAIN NOZZLE FLANGE (SB-381 GR.F3)	4	MATERIAL SHALL BE AS PER FOLLOWING: i) ASME CODE 2021 EDITION TO BE FOLLOWED WHEREVER EDITION IS MENTIONED IN DRAWING. ii) ALL CLAUSES OF THE Drg.4-16010-09728 REV.00 ARE TO BE STRICTLY ADHERED TO. iii) 100% INSPECTION AND CERTIFICATION BY M/S BHEL APPROVED TPIA FOR INDIAN SUPPLIERS. iv) FOREIGN SUPPLIERS CAN APPOINT ANY ONE OF THE BHEL APPROVED TPIA NAMELY M/s DNV, M/s LLOYDS, M/s BV, M/s TUV. v) ITEMS SHALL NOT BE MANUFACTURED FROM MELTED OUT SCRAP TITANIUM MATERIAL.	
	4	HE9715004970	4" DRAIN NOZZLE FORGING (SB-381 GR.F3)	4	MATERIAL SHALL BE AS PER FOLLOWING: i) ASME CODE 2021 EDITION TO BE FOLLOWED WHEREVER EDITION IS MENTIONED IN DRAWING. ii) ALL CLAUSES OF THE Drg.4-16010-09715 REV.00 ARE TO BE STRICTLY ADHERED TO. iii) 100% INSPECTION AND CERTIFICATION BY M/S BHEL APPROVED TPIA FOR INDIAN SUPPLIERS. iv) FOREIGN SUPPLIERS CAN APPOINT ANY ONE OF THE BHEL APPROVED TPIA NAMELY M/s DNV, M/s LLOYDS, M/s BV, M/s TUV. v) ITEMS SHALL NOT BE MANUFACTURED FROM MELTED OUT SCRAP TITANIUM MATERIAL.	
	5	HE9715004989	CW OUTLET NOZZLE FORGING (SB-381 GR.F3)	2	MATERIAL SHALL BE AS PER FOLLOWING: i) ASME CODE 2021 EDITION TO BE FOLLOWED WHEREVER EDITION IS MENTIONED IN DRAWING. ii) ALL CLAUSES OF THE Drg.4-16010-09715 REV.00 ARE TO BE STRICTLY ADHERED TO. iii) 100% INSPECTION AND CERTIFICATION BY M/S BHEL APPROVED TPIA FOR INDIAN SUPPLIERS. iv) FOREIGN SUPPLIERS CAN APPOINT ANY ONE OF THE BHEL APPROVED TPIA NAMELY M/s DNV, M/s LLOYDS, M/s BV, M/s TUV. v) ITEMS SHALL NOT BE MANUFACTURED FROM MELTED OUT SCRAP TITANIUM MATERIAL.	
	6	HE9715004997	CW INLET NOZZLE FORGING (SB-381 GR.F3)	2	MATERIAL SHALL BE AS PER FOLLOWING: i) ASME CODE 2021 EDITION TO BE FOLLOWED WHEREVER EDITION IS MENTIONED IN DRAWING. ii) ALL CLAUSES OF THE Drg.4-16010-09715 REV.00 ARE TO BE STRICTLY ADHERED TO. iii) 100% INSPECTION AND CERTIFICATION BY M/S BHEL APPROVED TPIA FOR INDIAN SUPPLIERS. iv) FOREIGN SUPPLIERS CAN APPOINT ANY ONE OF THE BHEL APPROVED TPIA NAMELY M/s DNV, M/s LLOYDS, M/s BV, M/s TUV. v) ITEMS SHALL NOT BE MANUFACTURED FROM MELTED OUT SCRAP TITANIUM MATERIAL.	

Vendor's
Sign With Seal

S NO	ITB Clause No.	TERMS & CONDITIONS	BHEL REQUIREMENT	VENDOR 'S CONFIRMATION
I				
TECHNICAL TERMS				
1		DESCRIPTION, SIZE & QUANTITY	As per Annexure-A ; Sign and stamp copy to be submitted along with offer documents giving confirmation to the same.	
2		Technical terms and Material specification	As per Annexure-A ; Sign and stamp copy to be submitted along with offer documents giving confirmation to the same.	
3		QUALITY PLAN	HYQA/VSQP/2023-24/1032006900/303 Rev.00 shall be followed.	
4		PACKING & MARKING	Foreign vendors shall provide sea-worthy packing.	
5		PQC	PQC for Lot 1 : HE-HEC-TIFORGSML REV.00 duly filled, signed & sealed to be submitted along with supporting documents as mentioned in PQC. PQC for Lot 2: HE-HEC-TIFORGMED REV.00 duly filled, signed & sealed to be submitted along with supporting documents as mentioned in PQC.	
6	36	INSPECTION & CERTIFICATION	<u>For Indian Vendors:</u> By BHEL / BHEL TPIA <u>Note:</u> (a) Vendors are advised to raise Inspection Call in CQIR system (www.cqir.bhel.in) with Purchasing Unit as 'HPEP' at least 3 working days prior to the proposed date of inspection. (b) For arranging customer inspection, advance intimation of 7 working days shall be provided.	
			<u>For Foreign Bidders:</u> FOREIGN SUPPLIERS CAN APPOINT ANY ONE OF THE BHEL APPROVED TPIA NAMELY M/s. DNV, M/s LLOYDS, M/s BV , M/s TUV.	
II				
COMMERCIAL TERMS				
1	3	Mode of Submission	Refer Sl. No. 5Bi of ITB Rev.13	
2	6	TERMS OF DELIVERY	FOR BHEL RC Puram for Indian vendors.	
			CIP Mumbai for Foreign vendors.	
2A		FOR BHEL Price / Delivery implies	a) Freight & Insurance are in vendor's scope and price quoted is inclusive of F&I.	
			b) C-Note date or Date of submission of documents whichever is later shall be considered as delivery date incase documents are not submitted within 10 days from the dispatch of the material.	
2B		CIP Mumbai price / delivery implies (for Foreign suppliers)	a) As per Incoterm.	
			b) IGM date in Bill of Entry issued by customs shall be delivery date for the purpose of penalty.	
			c) Exchange rate for Foreign Currency to INR shall be as per SBI Exchange rate (TT Selling rate) as on Technical Bid Opening date. If the relevant day happens to be a bank holiday, then the forex rate as on the previous bank (SBI) working day shall be taken.	
3		PACKING & FORWARDING	P & F charges shall be inclusive in price.	
4		FRIEGHT & INSURANCE	By supplier up to delivery point.	
5		Basic Custom Duty	Merit duty	
6	10	Price Validity	90 Days from Part-I bid opening date.	

7		Third Party Inspection Charges	Indian Vendors: By BHEL and vendor's offer will be loaded by appropriate percentage for evaluation of offers. Currently it is 0.198%.	
			Foreign Vendors: Shall be inclusive in quoted price.	
8	13	Maximum Penalty Applicable on	Delayed Portion Value.	
9	8	DELIVERY	Delivery shall be within 16 Weeks from the date of P.O	
			Note: For any deviation in delivery period for each item and schedule as indicated above, quoted price shall be loaded by 0.5% per week for evaluation of offer. However, BHEL reserves the right to reject the offers with delivery period not meeting the project requirement.	
10	23B	MSE CLAUSE	"MSE suppliers can avail the intended benefits only if they submit along with the offer, Udyam Registration Certificate. Non submission of such documents will lead to consideration of their bid at par with other bidders. No benefit shall be applicable for this enquiry if any deficiency in the above required documents are not submitted before price bid opening. If the tender is to be submitted through E-Procurement portal, then the above required documents are to be uploaded on the portal. Documents should be notarized or attested by a Gazetted Officer."	
11	Others	Contract Execution Bank Guarantee	Not Applicable.	
12	17	Performance Bank Guarantee	Not Applicable.	
13	5B	TWO-PART BID	Your offer shall be submitted in two part bid system Part-1 (i.e, Techno-Commercial bid including Pre-qualification) and Part-2 (Price bid) separately in two sealed covers indicating our enquiry No. D5A1X20339 date and tender due date clearly. Note: Pre-Qualification Criteria is part of techno-commercial bid. BHEL prefers to evaluate Pre-Qualification Criteria of vendors first and rest of the techno-commercial bid subsequently. However, at its discretion BHEL may evaluate both Technical and Pre-Qualification Criteria simultaneously.	
14A		TECHNO-COMMERCIAL BID	Techno-Commercial Bid shall essentially consist of: (i) Duly filled in signed and stamped Special Contract Conditions (SCC). (ii) Duly filled in signed and stamped Instructions to Bidder (ITB). (iii) Annexure C (Breach of contract, remedies & termination) (iv) Duly filled in signed and stamped Pre-Qualification Criteria (PQC : HE-HEC-TIFORGMED REV.00 & : HE-HEC-TIFORGSML REV.00) along with its Annexure and supporting documents for qualification. (v) Duly filled in signed and stamped Annexure-A, Technical terms and material specification. (vi) Udyam Registration Certificate for MSE vendors (vii) Local Content Certificate (Annexure-III), if applicable. (viii) Documents/declarations in compliance with Annexure-A, B (Guidelines for Indian Agents of Foreign Suppliers if applicable) (ix) Details as per Annexure-IV, if applicable (xi) Duly filled in Annexure-II (Non-Disclosure agreement) (xii) Duly Signed and Stamped Unpriced Bid Format. All the above documents shall be duly authenticated by signature & official stamp on each page. Note: Bid shall be complete in all respects including all the documents / information required for techno-commercial evaluation. Incomplete offers shall be liable to rejection.	
14B		PRICE BID	Quoted price shall be on firm basis.	

15	18	EVALUATION OF OFFERS	L1 bidder will be evaluated on Lot wise destination cost to BHEL basis (As per Annexure A). If vendor doesnot quote for all the items, their offer will not be considered. Sign and stamp copy of Annexure-A to be submitted along with offer documents giving confirmation to the same.	
16		REVERSE AUCTION	BHEL shall be resorting to Reverse Auction (RA) (Guidelines as available on www.bhel.com) for this tender. RA shall be conducted among the techno-commercially qualified bidders. Price bids of all techno-commercially qualified bidders shall be opened and same shall be considered for RA. In case any bidder(s) do(es) not participate in online Reverse Auction, their sealed envelope price bid along with applicable loading, if any, shall be considered for ranking.	
			RA representative details like Name, e-mail, Phone No. etc.	
17		PURCHASE PREFERENCE TO MSE SUPPLIER	Purchase Preference shall be in line with Order No. F.1/4/2021-PPD Dated 18.05.2023 issued by Ministry of Finance.	
18		GUIDELINES REGARDING DEALINGS WITH INDIAN AGENTS OF FOREIGN SUPPLIERS	It shall be incumbent on the Indian agent and the foreign principal to adhere to the relevant guidelines of Government of India, issued from time to time.	
			The Agency Agreement should specify the precise relationship between the foreign OEM / foreign principal and their Indian agent and their mutual interest in the business. All services to be rendered by agent/ associate, whether of general nature or in relation to the particular contract, must be clearly stated by the foreign supplier/ Indian agent. Any payment, which the agent or associate receives in India or abroad from the OEM, whether as commission or as a general retainer fee should be brought on record in the Agreement and be made explicit in order to ensure compliance to laws of the country.	
			Any agency commission to be paid by BHEL to the Indian agent shall be in Indian currency only.	
			Tax deduction at source is applicable to the agency commission paid to the Indian agent as per the prevailing rules.	
			In the absence of any agency agreement, BHEL shall not deal with any Indian agent (authorized representatives / associate / consultant, or by whatever name called) and shall deal directly with the foreign principal only for all correspondence and business purposes.	
			The "Guidelines for Indian Agents of Foreign Suppliers" enclosed at annexure – 'A' shall apply in all such cases.	
			The supply and execution of the Purchase Order (including indigenous supplies/ service) shall be in the scope of the OEM/ foreign principal. The OEM/ foreign principal should submit their offer inclusive of all indigenous supplies/ services and evaluation will be based on 'total cost to BHEL'. In case OEM/ foreign principal recommends placement of order(s) towards indigenous portion of supplies/ services on Indian supplier(s)/ agent on their behalf, the credentials/ capacity/ capability of the Indian supplier(s)/ agent to make the supplies/ services shall be checked by BHEL as per the extant guidelines, before opening of price bids. In this regard, details may be checked as per Annexure-B (copy enclosed). It will be the responsibility of the OEM/ foreign principal to get acquainted with the evaluation requirements of Indian supplier/ agent as per SEARP available on www.bhel.com.	
			As per directives of CENTRAL VIGILANCE COMMISSION, GOVERNMENT OF INDIA, one agent can not represent two or more suppliers or quote on their behalf in a particular tender. If so found at any stage, BHEL Hyderabad is likely to cancel Enquiries / POs to such suppliers. Further, such Indian Agent is likely to be de-listed (Black listed for business from BHEL).	

19	16	GUARANTEE	Guarantee on the supplies for a period of 18 months from the date of dispatch or 12 months from the date of commissioning whichever is earlier.	
20	12E	EARNEST MONEY DEPOSIT (EMD)	EMD charges not applicable for quoting against this tender.	
21	27	Risk Purchase clause	As per Annexure C. Vendor to submit signed & attested copy of Annexure C.	
22		FINANCIAL STANDING	Indian Bidders: Vendor to submit annual Financial Turnover during the Past 3 Years along with copy of 3 years Audited Balance Sheet.	
			Foreign Bidders: Vendor to submit copy of latest D&B Report.	
23		TERMS & CONDITIONS	Vendor is requested to furnish all details of the offer in this format. In case of any discrepancy between information furnished here and those furnished elsewhere in the bid, the information furnished in this document only shall be considered, and those furnished else where shall be ignored.	

**BHEL Enq No. D5A1X20339**

(Attachment to Enquiry No. XXXXXXXXXXXX Due on Date XX.XX.XXXX for submission by 11.00 hrs to open from 14.00 hrs.)

INSTRUCTIONS TO BIDDER (ITB)**NOTE: Bidder to confirm in affirmative by typing "YES" or "Applicable Data" in the response column. Deviations, if any shall be recorded in deviations/comments column (Separate sheet can be attached if needed). Non deviatable clauses are indicated as "NON DEVIATABLE".**

Sl. No.	DETAILED TERMS & CONDITIONS	BIDDER RESPONSE (YES/NO)	DEVIATIONS / COMMENT
1	SCOPE OF SUPPLY:		
	Signed & Sealed offers are invited for the Scope of Supply of goods or services or both as detailed in the enquiry. Relevant enclosures/supporting documents / catalogue, if any shall be enclosed to the technical offer.		
2	DEFINITIONS		
A	'The Buyer' means BHEL-HPEP, Ramachandrapuram, Hyderabad-502 032 of Bharat Heavy Electricals Limited (A Govt. of India Undertaking) incorporated under the companies Act having its registered office at BHEL House, Siri fort, New Delhi-110049, India and shall be deemed to include its successors and assigns. It may also be referred to as BHEL.		
B	'The Bidder' means the persons, firm, company or organization on whom the Purchase order is placed and shall be deemed to include the bidder's successors, representatives, heirs, executors and administrator as the case may be. It may also be referred to as Contractor, supplier or bidder.		
C	'Contract' shall mean and include the Purchase order incorporating various documents viz., Notice Inviting Tender (NIT), Offer, Letter Of Intent/Acceptance (LOI/LOA), Instruction to Bidders (ITB) and Special Conditions of Contract (SCC), specifications, inspection/quality plan, schedule of prices and quantities, drawings, if any, enclosed by Bidder/ provided by the Buyer or his authorized nominee and the samples or patterns if any to be provided under the provision of the contract. In case of any inconsistency or contradiction between any of the documents, the order of precedence shall be Purchase Order, LOI/LOA followed by Minutes Of Meeting (MOM), NIT, SCC, ITB.		
D	'Parties to the contract' shall mean the bidder and the buyer as named in the main body of the Purchase Order.		
E	'Goods/Material' shall include Works and Services which are incidental or consequential to supply.		
3	GENERAL INSTRUCTIONS:		
A	Mode of submission of offer shall be as indicated in SCC		Non Deviatable
B	The quotation should be neatly typed and free from over writing/ erasures. Any correction or addition must be authenticated. The offer including annexures and brochures should be submitted in English / Hindi. All Pages of Techno Commercial Bids (Main Pages), ITB, SCC should be signed and Stamped. If there is a conflict in case of bilingual submission, the submission in English will be final. Prices shall be quoted both in figures and words. In case of any discrepancy in value, the prices quoted in words shall be considered for evaluation and establishing L1 Status. Any discount / revised offer / bids submitted by a bidder on his own shall be considered, provided it is received on or before the due date and time of offer / bid submission (Part-1). Conditional discounts shall not be considered for evaluation of tenders.		Non Deviatable
C	Incomplete offers are liable for rejection.		Non Deviatable
D	Bidders to please note that the Terms & conditions contained in this document and SCC are to be read fully before submission of quotations.		Non Deviatable
E	Bidders are advised to comply with ITB and SCC, should there be any deviations (where deviations are permitted), it shall be entered in the deviation column. BHEL reserves the right to reject such offers or load the bid suitably for evaluation.		Non Deviatable
F	Offers shall be submitted directly, only by the bidder or by their authorized representative / agent and the offer should be in line with the regulatory guidelines (i.e. A valid Agency agreement between principal bidder and agent / representative shall be attached and the agreement shall cover the scope of services rendered by Agent, Agency Commission and any other information called for as per the regulatory guidelines). OEM / Mill details shall be provided if bidder is not a manufacturer. Bid envelopes shall bear the name of Bidder. In case of submission through authorized representative/agent, the name of representative/agent should also be mentioned apart from bidder name.		Non Deviatable
G	Offer received after the specified time and date of submission will be rejected. No further correspondence shall be entertained.		Non Deviatable
H	Unsolicited offers will not be considered.		Non Deviatable
4	OTHER PARTICULARS (Please indicate applicable data)		
A	Name of the Bid currency (freely tradable foreign currency for imports and Indian Rupees for indigenous purchase).		
B	Name of the Port of loading and Port of Discharge (applicable to imports).		

**BHEL Enq No. D5A1X20339**

5	BID SUBMISSION PROCEDURE FOR CONVENTIONAL TENDER:	
A	For Single Part Bids:	
	The complete bid shall be submitted in a single sealed cover superscribing the Tender number and due date, addressed to Sr DGM/CMM, Vendor Complex, BHEL, Hyderabad and sent by appropriate mode to above address or dropped in tender box located at vendor complex on or before the specified time and date of submission of offers, preferably in the bidder's envelope. E- mail bids shall be sent to mail ID pricebid_hyd@bhel.in only as an attachment.	Non Deviatable
B.	For two-Part Bids:	
i	<p>The offer is to be submitted in two parts viz., Techno-commercial Bid - (Part-I), with all technical specification & scope including bill of material etc., Earnest Money Deposit (EMD)(wherever applicable) and unpriced bid with all applicable Commercial Terms and Conditions, rates of agency commission, duties, taxes and other charges, Signed and Stamped ITB and SCC, <u>except the price</u>, shall be kept in a separate sealed cover, superscribing enquiry No. (Techno-Commercial Bid) and due date AND Price Bid (Part-II), containing ONLY the price (including agency commission, if any) and the applicable duties/taxes/other charges shall be kept in a separate sealed cover superscribing Enquiry no. (Price bid) & due date.</p> <p>Both the above covers (Part –I & II) shall be kept in a Third cover superscribing Enquiry no. & due date.</p> <p>Bidder can also submit offer through email. Technical offer to be submitted to mail ID technicalbid_hyd@bhel.in, and price bid to be submitted to mail ID pricebid_hyd@bhel.in only as an attachment. Interchanging the information in the mails may lead to rejection of the offer. Bidder shall have no claim on e-mail offers sent to any other e-mail ID.</p> <p>In case of e-mail offers, the mail subject should contain Enquiry Number, Due date and Bidder name. Bidder address including contact details shall be mentioned in the content of the mail. Without these details, the offer is liable for rejection.</p> <p>All techno commercial terms & conditions mutually agreed prior to price bid opening shall prevail and supersede any terms and conditions specified otherwise in price bid.</p>	Non Deviatable
ii	The bidders whose bids are techno commercially not accepted will be informed and EMD shall be returned wherever submitted.	
iii	Bidders will be allowed to submit the impact on their quoted prices due to changes in technical scope, specifications, and commercial terms/conditions as specified in NIT which in the opinion of BHEL , warrant changes in prices.	Non Deviatable
C	Bids shall be opened on due time and date in the presence of bidders who may like to be present. Only one representative of each bidder shall be permitted to attend the bid opening. Only the price bids of bidder (in case of two part bid) whose techno commercial bids are accepted will be opened later on a specified date.	Non Deviatable
6	DELIVERY TERMS	
A	Indigenous Purchase	
	<p>a. Terms of Delivery for dispatches to BHEL Hyderabad (HPEP) shall be FOR Destination.</p> <p>b. Terms of Delivery for Direct Dispatch (DD) items shall be Ex Works.</p> <p>i. In case specified in SCC that insurance is in customer/BHEL scope, price quoted shall include Freight charges up to Destination.</p> <p>ii. Otherwise, price quoted shall include Freight and Insurance upto Destination. However, beneficiary for insurance shall be BHEL.</p>	
B.	Imports	
	The goods shall be delivered on FCA capital airport basis in case of freight by Air and CIP basis in case of freight by Sea.	
7	Documentation for Payment	
A	Indigenous Purchase	
	<p>Following documents shall be submitted immediately on dispatch of material to BHEL HPEP / Site</p> <p>a. Original Tax Invoice (Refer ITB clause no 11 for Tax Compliance)</p> <p>b. Packing List - clearly showing number of packages, gross weight and net weight.</p> <p>c. Test/Warranty/Guarantee certificates, O&M Manual (If specified in SCC)</p> <p>d. Insurance intimation/declaration certificate</p> <p>e. Pre-dispatch Inspection report /Third Party Inspection Certificates.</p> <p>f. Consignee copy of LR signed & stamped by Customer/Site representative for DD Items</p> <p>g. e-waybill</p> <p>h. Any other documents as specified in SCC.</p> <p>Softcopies of the above documents shall be uploaded in Pradan portal https://hpep.bhel.com/mm immediately after dispatch of the material.</p>	Non Deviatable

**BHEL Enq No. D5A1X20339**

<p>B Imports</p> <p>i) Bidder shall inform BHEL the readiness of material along with packing details 30 days in advance from the date of delivery. For Hazardous cargo/DG cargo, supplier must provide the following documents prior to handing over shipment to freight forwarder, wherever freight is in BHEL scope:</p> <ol style="list-style-type: none"> 1. Valid MSDS 2. DGD certificate with appropriate UN numbers. 3. Labelling and marking on DG cargo along with photo of packaging. 4. Self-declaration for consignment 5. Packaging Certificate as per DG Standards 6. TSA Approved Truckers details to be provided to forwarder at the time of shipment <p>In addition to the above, supplier should ensure to comply all IATA DG regulations, if any new requirement is added in future.</p> <p>ii). Bidder shall also upload the soft copy of the dispatch documents consisting of BL / AWB, Invoice, delivery note, packing list, country of origin & Test certificates and other documents as specifically indicated in the SCC in PRADAN Portal (https://hpep.bhel.com/mm) within Five days from the B/L date for sea shipment and One day from AWB date for Air shipment and sent to email ids: mssea@bhel.in, msair@bhel.in, cmmfe@bhel.in.</p> <p>iii) AWB/BL must contain the information of BHEL GST no., and PAN no.</p> <p>iv) Air Shipments: Bidder shall ensure the following</p> <ol style="list-style-type: none"> a) Port of discharge -- Mumbai/Chennai/Hyderabad (as indicated in SCC). b) Consignee shall be BHEL, Hyderabad. Material shall be air freighted through cargo mode only and not through Courier. c) Upon handing over the cargo to the forwarder, bidder shall ensure the acknowledgement receipt with wordings "Cargo handed over in sound condition for Air freighting". Note: Warehouse receipt will not be considered for penalty calculations. d) In case of CIF/ shipments, bidder shall also inform BHEL the information about discharge port agent details and cargo arrival information within one day from the date of Shipment. e) Following dimensions of single package may be noted. <ol style="list-style-type: none"> i). Maximum dimension of the cargo(ODC) -- 125" x 88" x 63" ii). Maximum weight of the cargo -- 3.5 MT. <p>If any package dimension or weight exceeds the above set limits, it will be treated as Over Dimension Cargo (ODC) or Over Weight Cargo and bidder shall inform BHEL 30 days in advance to the delivery date to enable BHEL to finalize the freight forwarder.</p> f). If package falls under Hazardous category, bidder shall communicate BHEL 30 days in advance period with document support. <p>v) Sea Shipments:- bidder shall ensure the following</p> <ol style="list-style-type: none"> a). Port of discharge -- Nhavaseva/Mumbai/Chennai. b). Place of Delivery / Final Destination for CIP shipments - Nhavaseva CFS / Chennai CFS. c). In case of FOB shipments, bidder shall handover the material to BHEL nominated forwarder and obtain the cargo receipt. d). If the material cannot be containerized in 20 or 40 GP containers, an advance information of 30 days prior to the delivery date shall be communicated to BHEL for necessary arrangements and finalisation of freight forwarder. e). For CIP shipments <ol style="list-style-type: none"> 1. In case of FCL shipments, Detention free period must be 14 days. 2. Bidder shall also inform BHEL the information about discharge port agent details and cargo arrival information within 5 days from the date of Shipment. 3. No charges for the services rendered till place of destination will be payable by BHEL. In case liner / forwarder insist for charges, not in the scope of BHEL, the same will be adjusted from bidder account. 4. In case of CIF shipments -- Bidder must select a forwarder/liner whose discharge port published tariff for THC and other services is available. Any charges over and above the published tariff will not be borne by BHEL or will be adjusted from the bidder's bill. 5. bidder must insure the cargo for 110% of material value including the freight amount. (vi). Recovery charges for non-submission of documents: - Bidder shall submit all the required documents to BHEL as prescribed in the Purchase order and NIT. <p>If BHEL incurs any charges such as Penalty, demurrage, container detention, wharfage, storage, Ground rent etc., due to non - compliance / non - submission of documents prescribed in Purchase Order/ NIT/Letter of credit, the same shall be recovered from the bidder as under:</p> <ol style="list-style-type: none"> 1. EUROPE/USA/Black Sea/ Far East/Middle East/South East sector <p>A. For FOB Sea Consignments:-</p> <p>Penalty for late submission / negotiation of documents beyond 14 days shall be as under:</p>		
--	--	--



BHEL Enq No. D5A1X20339

Sl. no	Period (From Date of Bill of Lading)	Recoverable Charges		Recoverable Charges per day per container	
		LCL Break per day	per week/ bulk cargo	20FT Container	40FT Container
i	Upto 14th day	Nil		Nil	Nil
ii	15th day onward	USD 10		USD 110	USD 200

B. For CIP Sea Shipments: -
 Bidder shall provide rates for detention charges after free period at the time of offer itself in case of engagement of 20FT Container and 40FT category. In case of late presentation of documents to the bank recovery will be effected from the Bidder as per the rates quoted by the Bidder at the time of offer in this regard.
 In case of Break bulk cargo and LCL, Demurrage charges shall be recovered at the rate of USD 1 per Ton per day and storage charges at the rate of USD 10 per week respectively shall be charged as late presentation charges.

(vii) Description of items in invoice, packing list, BL / AWB or LR shall be same as PO item description. Bidders shall ensure that invoice shall contain PAN nos. of both bidder and BHEL along with other tax related numbers. BHEL PAN AAACB4146P and BHEL TAN HYDB00086C Any other additional documents sought by the statutory authorities, the same shall be produced by the bidder on priority basis.

(viii) Bidder shall provide package details including number of packages, gross weight, net weight etc.

(ix) The bidder shall provide the following documents at the time of submission of offer:
 a) No Business Connection in India declaration issued by the bidder as per the format specified. (or)
 b) (i) No Permanent Establishment in India declaration issued by the bidder as per the format specified.
 (ii) Tax Residence Certificate issued by the bidder's tax authorities.
 (iii) Form 10F, as attached in Annexure V, to be issued by the bidder.
 c) In case the bidder has a Business Connection in India as per Section 9 of Income Tax Act or significant economic presence in India as per rule 11 UD of IT Act or Permanent Establishment in India as per Article 5 of Double Taxation Avoidance Agreement between India and the bidder's country, the bidder shall provide a withholding tax order issued by the Indian Income Tax authority for recovery of applicable tax.

8	Delivery Schedule		
	The tendered goods shall be delivered within the period stipulated in NIT/ SCC as accepted. Inordinate delay/early supply are liable for rejection/ Hold on payment.		Non Deviatable
9	Pricing Terms		
	Quoted price shall be inclusive of Packing & Forwarding and shall remain firm and valid during the execution of PO. Offers with PVC will be rejected outright except in cases where specifically called for in the SCC.		Non Deviatable
10	PRICE VALIDITY :		
	Unless otherwise specified, offer shall be valid for a period of 90 days from the date of bid opening (Technical bid /part-I in case of two part bid). However the prices quoted for spare parts of the Main equipment shall be kept valid for a period as specified in SCC.		Non Deviatable
11	Taxes & Duties (RATE TO BE INDICATED by the bidder against the space provided)		



BHEL Enq No. D5A1X20339

<p>A</p>	<p>Indigenous Purchase</p> <p>i) Only valid GST registered bidders will be considered for the tender. The GSTIN of the bidder should be clearly mentioned in the offer. ii) If bidder is exempted from GST registration under any provision of the GST Law, a declaration with due supporting documents should be furnished for considering the offer. iii) Bidder to quote the applicable taxes in the following manner: - Harmonized System of Nomenclature (HSN) of Goods - Services Accounting Code(SAC) of Services. - IGST/CGST/SGST/UTGST: Rate of Tax to be quoted as extra in % against the space provided iv) Bidders to ensure correct applicability of IGST/CGST/SGST/UTGST based on the Inter / Intra state movement of goods/services. v) In case Bidder has opted for GST Composition Scheme, the same may be stated explicitly both in their technical and price bids. An undertaking to the effect that any change in the status of the bidder will be intimated. vi) Any other taxes & duties not covered anywhere above may be indicated separately.</p> <p>Taxes deducted at source: - TDS as per the extant statutes shall be deducted. - In case bidder does not provide PAN details, higher rate of tax shall be deducted as per the Act. - Concessional certificates, if any, should be provided well in time for lower deduction of tax.</p>		<p>Non Deviatable</p>
	<p>Terms & Conditions to be complied</p> <p>1. All invoices (incl. Credit Notes, Debit Notes) to contain BHEL HPEP GSTIN ie 36AAACB4146P1ZG. Invoices submitted should be in the format as specified under GST Law. All details as mentioned in Invoice Rules including Dealer GST registration number (GSTIN), invoice number with date of issue, quantity, rate, value, taxes with nomenclature – CGST, SGST, UGST, IGST mentioned separately, HSN Code / SAC Code etc. 2. Reimbursement of GST amount will be made only upon completion of the following: i. Bidder declaring such invoice in their GSTR-1 Return/ IFF ii. Receipt of Goods or Services and Submission of Tax invoice by BHEL iii. The tax invoice is reflected in the GSTR2B of BHEL, HPEP (buyer). Payment of GST will be made only if it is matching with data uploaded by the Bidder in GST portal. 3. In case of discrepancy in the data uploaded by the bidder in the GSTN portal vis-a-vis the tax invoice or in case of any shortages or rejection in the supply, then BHEL will not be able to avail the tax credit. The same would be available in PRADAN Portal for the bidder's information. Bidder has to rectify the data discrepancy in the GSTN portal or issue credit note or debit note (details also to be uploaded in GSTN portal) for the shortages or rejections in the supplies or additional claims for processing of such invoices. 4. In cases where invoice details have been uploaded by the bidder but failed to remit the GST amount to GST Department within stipulated time, then GST on the invoices in default will be recovered from the bidder along with the applicable interest. 5. In case GST credit is delayed/denied to BHEL due to non/delayed receipt of goods and/or tax invoice or expiry of timeline prescribed in GST law for availing such ITC, or any other reasons not attributable to BHEL, such GST amount will be recoverable from bidder along with interest levied/leviable on BHEL. 6. GST TDS deducted as per GST Act, is uploaded in GSTN portal along GSTR7. Bidders can directly download the GST TDS Certificate from the GSTN Portal. 7. Bidders to note that Rules & Regulations pertaining to E-way bill system are to be strictly adhered to, as and when notified by Govt. authorities. 8. Vendors who fall under the E-Invoice regulations, i.e., having an annual turnover of Rs. 10 crores (Rs 5 crore w.e.f 01.08.2023) in the previous year shall issue e-invoice in line with Rule 48(4) of CGST Rules failing which GST amount will not be reimbursed to the vendor even if the other requirements are fulfilled. 9. In case the vendor is exempted by the GST department under the Rule 48(4) of CGST Rules from issuing E-invoice, a declaration as prescribed in the Notification 17/2022 - Central Tax dated 01-08-2022 shall be provided on the invoice. 10. Vendors who do not fall under the E-Invoice regulations, i.e., whose annual turnover is less than Rs. 10 crores (Rs 5 crore w.e.f 01.08.2023) in the previous year have to give an undertaking indemnifying BHEL that the vendor is not falling under the E-invoice requirement category and that in case of any breach of this E-invoicing requirement, the vendor indemnifies BHEL of any consequences that may arise due to such a breach. 11. No GST shall be levied on liquidated damages / penalty.</p>		
<p>B.</p>	<p>Foreign Purchase (Imports)</p>		

**BHEL Enq No. D5A1X20339**

	The offered price shall be inclusive of all the Taxes and duties as applicable in country of export / country of dispatch for the quoted price. Taxes deducted at source: a. In case of goods or services subject to Income tax in India, such tax as per the extant statute shall be recovered. b. In case bidder does not provide necessary documents for beneficial taxation (Refer clause 7-B-(ix) a-c of ITB), the TDS deduction shall be at the maximum percentage stipulated as per the provisions of Income Tax Act.		Non Deviatable
12	Payment Terms: Unless otherwise specified in SCC, following shall be the terms of Payment.		
A	Indigenous: a. Micro & Small Enterprises (MSEs) - 100% Direct EFT payment within 45 days b. Medium Enterprises - 100% Direct EFT payment within 60 days c. Non MSME Bidders - 100% direct EFT Payment within 90 Days Note A. Above due date is reckoned from the date of Receipt of material or 15 days from the date of submission of complete set of documents as per PO whichever is later. Payment will be made on acceptance of Material. B. MSEs (covered under MSME Act) need to register and renew periodically and update the same with BHEL C. The taxes that are reimbursed are limited to applicable taxes as on the Purchase Order delivery date or the amount actually paid whichever is less. D. Adherence to the above time schedule of payment is contingent upon Bidder complying with GST provisions and availment of Input Tax Credit by BHEL before the date of payment. E. In case of packaged items, 10% of supply value will be retained till completion of total supplies. F. Bidders to comply with clause 11 on GST requirements G. MSE benefits are not applicable to Traders/Wholesalers registered as MSEs		
B	Imports: i) 100% payment (less Indian Agency Commission, if any) shall be through Wire Transfer with a credit period of 60 days - Cash Against Documents (CAD) ii) In case Bidder opts for Letter of Credit payment, the LC Usance period shall be 90 days with respective bank charges to respective accounts and loading of 0.50% iii) Indian Agency commission if payable and so specified in the Purchase order shall be paid in Indian Rupees, considering the SBI TT selling exchange rate, as on the date of payment after successful completion of the contract.		
C	Conditions for LC: a. LC validity period will be 90 days and for any extension, applicable charges will be to bidder's account. b. LC will be opened after successful completion of pre dispatch inspection prior to the scheduled / agreed delivery date. LC will be opened within 15 bank working days from the date of request.		Non Deviatable
D	Conditions for both Indigenous & Foreign Bidders: a. In case Bidders insist for lesser Credit period and BHEL accepts, a loading of 0.60% for every 15 days reduction will be applicable. b. In case PBG as required is not furnished, Payment will be released deducting the BG amount, which will be paid after expiry of warranty period against submission of supplementary claim. c. Payment does not imply in any respect whatsoever a waiver of Buyer's right to performance of the Order. Buyer is entitled to set off claimable debts against claimable liabilities with the bidder by means of a setoff Note.		Non Deviatable
E	Wherever EMD is applicable, the EMD will be paid back to unsuccessful bidders within fifteen days after award of the contract. Successful bidder's EMD will be retained till submission of Performance Bank Guarantee (PBG). Tender Fee wherever applicable is not refundable. No interest shall be payable by BHEL on earnest money or security deposit or any money due to the contractor by BHEL.		Non Deviatable

**BHEL Enq No. D5A1X20339**

13	Penalty clause:		
	<p>In the event of delay in supply /part-supply of goods, Penalty as detailed below is leviable</p> <p>a. Penalty of 0.5% per week or part there of shall be levied, limited to a max of 10% (ten percent) of delayed portion value / order value (as specified in SCC).</p> <p>b. Penalty applicable for delay in documentation is as per SCC.</p> <p>c. Date Reckoned for Penalty</p> <ul style="list-style-type: none"> - Indigenous Orders with delivery terms FOR HPEP: C Note date. - Indigenous Orders (Others): Date of e-waybill. - Imports: For CIP/CIF Orders: IGM date - Imports: For FOB Orders: AWB / BL date - Imports: For FCA/Ex Work Orders: Date of acknowledgement from Freight Forwarder. <p>d. In case of Deviation to above Penalty clause, loading applicable to the extent to which not agreed by Bidder.</p> <p>e. Timelines as mentioned in the Annexure 1 will be considered for reckoning delivery.</p> <p>Penalty amount so determined along with applicable GST (for Indigenous orders) thereon shall be recovered.</p> <p>Imposition, recovery or settlement of this penalty shall not affect BHEL's right to performance, compensation and termination of the order.</p>		
14	Excess materials supplied beyond tolerance limit as specified in PO will not be paid and bidder may raise credit note for the excess/unaccepted material as per GST law.		Non Deviatable
15	Rejected materials , if any, shall be collected by the bidder within 90 days of such communication to the bidder. Beyond this period the bidder forfeits their right to the materials.		Non Deviatable
16	<p>Guarantee / Warranty Period:</p> <p>Wherever required, and so provided in the specifications/SCC/Purchase Order, the bidder shall guarantee that the goods supplied shall comply with the specifications laid down, for materials, workmanship and performance.</p> <p>a. Guarantee period shall be 12 months from the date of commissioning or 18 months from the date of supply whichever is earlier.</p> <p>b. In case erection & commissioning is involved, guarantee period shall be 12 months from the date of commissioning.</p> <p>c. In case of equipment bought as a package which are intended to be incorporated in installations or systems, the guarantee period shall be 12 months from the date of commissioning of such equipment.</p> <p>The guarantee period shall be extended by the period during which the goods are not in compliance. If the delivery is found to be non-complaint, bidder shall replace, repair or re-execute the as requested by BHEL. If the bidder defaults on his obligations, buyer has the right to proceed to replace, repair or re-execute at the bidder's expense.</p> <p>A guarantee period as described above shall apply afresh to replaced, repaired or re-executed parts of a delivery.</p> <p>Loading for deviation:</p> <p>In case warranty specified in SCC is over and above the period mentioned in b & c above; loading will be 1% per annum for the deviation in warranty end period, on the contract value. Expected commissioning period is as indicated in SCC.</p>		Non Deviatable
17	<p>PERFORMANCE BANK GUARANTEE (PBG) (Applicable in case mentioned in SCC)</p> <p>In case enquiry specifically spells out PBG requirement, PBG is to be submitted by Bidder in requisite format as per Annexure VII.</p> <p>Further detailing on PBG as specified in SCC.</p> <p>The PBG shall be for the performance of the goods and shall remain binding not withstanding such variations, alterations or extensions of item as may be made, give, conceded or agreed to between the Bidder and BHEL under these Terms and conditions or otherwise.</p>		Non Deviatable
<p>NOTE: Deviations (Commercial as well as Technical) from the tender specifications and conditions are generally not acceptable. However, deviation if any, shall be brought out clearly with proper justification in the offer. The deviation, if considered by BHEL, shall be loaded for comparison, while evaluating the offer. If a bidder unconditionally withdraws any deviation before price bid opening, the same shall not be loaded. Loading criteria in respect of major commercial conditions where deviations if any are accepted shall be as per clause No.18.</p> <p>The Bidders may specifically note the following.</p>			
18	Evaluation and Loading Criteria:		

**BHEL Enq No. D5A1X20339**

- i) Evaluation Currency for this tender shall be "INR".
 ii) Evaluation of prices shall be done item-wise unless otherwise specified in the SCC.
 iii) Evaluation shall be on the basis of delivered cost, i.e. "Total Cost to BHEL" w.r.t the finalized technical scope and commercial conditions (after considering incidence of applicable taxes and duties and loading).
 iv) In the course of evaluation, if more than one Bidder happens to occupy L1 status, effective L1 will be decided by soliciting discounts from the respective L1 Bidders. In case more than one Bidder happens to occupy the L1 status even after soliciting discounts, the L1 Bidder shall be decided by a toss/draw of lots, in the presence of the respective L1 Bidders or their representatives. Ranking will be done accordingly. BHEL decision in such situations shall be final and binding.

INDIGENOUS

- a. Bidder shall ensure to indicate the applicable taxes against each line item, failing which the same will be considered as inclusive/NIL.
 b. Ex-works offers received (as against FOR Destination mentioned in enquiry) shall be loaded by 2% of Ex-works value.
 c. GST and any other charges quoted will be added to the base price. However, in case input credit is available for GST (SGST, CGST/IGST), the same shall be excluded for arriving at "Total Cost to BHEL"

IMPORTS

For evaluation of offers in foreign currency, exchange rate (TT selling rate of State Bank of India) as on the date of bid opening (Part-I, in case of two-part bids) shall be considered. If the relevant day happens to be a bank holiday, then the forex rate as on the previous bank (SBI) working day shall be taken.

In case of foreign Bidders, the quoted CIP price shall be loaded by the following factors to arrive at "Total Cost to BHEL":

- Import duty as applicable on the date of Part-I bid opening.

- Loading will be as per the table below

	Ex Works	FOB/FC A	CIF/CFR	CIP
Foreign Inland freight and insurance	2%			
Marine freight and marine insurance	3%	3%		
Destination Port handling charges	0.50%	0.50%	0.50%	
clearing charges & inland freight and insurance	2%	2%	2%	2%

COMMON LOADING FOR IMPORTS & INDIGENOUS that will be added for arriving the "Total Cost to BHEL"

- A. Loading on Deviated Penalty clause shall be 10% or to the extent to which the bidder has opted for deviation.
 B. Loading for payment terms as per clause 12 of ITB
 C. Loading for deviation in Warranty & PBG as per clause 16,17.

- 19** Procurement directly from the manufacturers/ suppliers shall be preferred. However, no agent shall be allowed to represent more than one manufacturer/ supplier in the same tender. Moreover, either the agent could bid on behalf of the manufacturer/ supplier or the manufacturer / supplier could bid directly but not both. In case bids are received from both from the manufacturer/ supplier and the agent, bid received from the agent shall be ignored.
- 20** **RIGHT OF REJECTION /NON- PLACEMENT OF PO:** BHEL reserves the right to accept or reject any or all bid/s in full or part without assigning any reason whatsoever.
- 21** **INTEGRITY PACT**
 Bidders shall have to enter into Integrity Pact with BHEL as per Annexure VI - for Tender value of rupees two crores and above and shall be signed by the authorized signatory along with the offer, failing which Bidder's offer will be rejected.
- 22** **Public Procurement**
- A** **Make in India**
 For this Procurement, the local content to categorize a bidder as a Class I local bidder / Class II local bidder / Non-Local bidder and purchase preference to Class I local bidder, is as defined in Public Procurement (Preference to Make in India) order No P-45021/2/2017-PP(BE-II) dated 04-06-2020 issued by DPIIT as amended from time to time. Proforma for self-certification for minimum local content and auditor's certification is given in Annexure III.
- B** Any Bidder from a country which shares a land border with India will be eligible to bid in this tender only if the bidder is registered with competent authority. GOI website <https://www.mea.gov.in/> to be referred for latest details of competent authority and exemptions . Proforma for self-certification for compliance is given in Annexure IV.
- C** **Startups:**
 For Start-ups duly registered with DPIIT (Copy of certificate to be provided), condition of prior turnover and prior experience in Public Procurement may be relaxed subject to meeting of Quality and Technical Specifications. Startups are exempt from paying EMD.
- 23** **Benefits earmarked for Purchase from Micro & Small Enterprises (MSEs) – Indigenous Purchase**
- A** All Micro and Small Enterprises (MSEs) as defined in MSE Procurement Policy are exempt from Paying EMD. NSIC/UDYAM registered bidders shall submit NSIC/UDYAM Certificate along with bid documents. Date to be reckoned for determining the deemed validity will be the last date of Technical bid submission. Non- submission of such document will lead to consideration of their bid, at par with other bidders and MSE status of such bidders shall be shifted to Non- MSE Category till the bidder submits these documents.

**BHEL Enq No. D5A1X20339**

B	In tender, MSEs quoting price within price band of L1+15% shall also be allowed to supply a portion of requirement by bringing down their price to L1 price in a situation where L1 price is from someone other than a MSE and such MSE shall be allowed to supply at least 25% of total tendered value. In case of more than one such MSE, the supply shall be shared proportionately. Out of these 25% minimum 3% shall be earmarked for MSEs owned by women and 6.25% for MSEs owned by SC/STs who submit the relevant documents.
C	If an enterprise falling under MSME category as defined in the Act, graduates to a higher category from its original category or beyond the purview of the Act, it shall continue to avail all non-tax benefits of its original category notified by the Ministry of Micro, Small and Medium Enterprise for a period of three years from the date of such graduation to the higher category.
D	BHEL HPEP is registered with RXIL (TReDS) platform. MSME bidders are requested to get registered with RXIL (TReDS) platform to avail the facility as per the GOI guidelines.
24	Inspection Measuring and Test Equipment (IMTE) used by the Bidder/ Contractor or sub-contractor shall be calibrated, maintained and controlled. Calibration shall be valid and IMTE maintained in sound condition during usage.
25	ISO-9001, ISO14001 & OHSMS 45001 shall be complied.
26	If BHEL registered supplier is not quoting against this NIT, supplier shall send regret letter positively with valid reasons for not participating. Repeated lack of response on the part of supplier may lead to deletion of such registered supplier from BHEL's approved supplier's list as per BHEL SEARP Guidelines.
27	Risk Purchase clause: In case bidder fails/delays to supply whole or part of the ordered items or supplies defective items or fails to fulfil any other terms and conditions given in Purchase Order/Contract, BHEL has the right to terminate the order/contract or withdraw balance scope of work/supply and make the purchase of such material / services from elsewhere at the risk and cost of the defaulted bidder. The bidder is liable for the additional expenditure / difference in Cost, if any, including consequential losses which BHEL may sustain by reason of risk purchase in addition to the applicable LD as per the order/contract. Non-performance of contract attracts penal provisions in line with BHEL guidelines for Suspension of Business Dealings (SBD).
28	Any other terms and conditions of the bidder attached / referred against the tender enquiry will not be considered.
29	All drawings, patterns and tools supplied by BHEL or made at BHEL's expense are BHEL's property. These cannot be used or referred to any other party and must be used only in the execution of BHEL's orders.
30	Any amount payable by the bidder under any of the conditions of this contract shall be liable to be adjusted against any amount payable to the bidder under any other work / contract awarded by BHEL HPEP or any other BHEL Units. This is without prejudice to any other action as may be deemed fit by BHEL.
31	The bids of the bidders who are on the banned list and also the bids of the bidders, who engage the services of the banned firms, will be rejected. The list of firms banned by BHEL is available on BHEL web site: www.bhel.com
32	Ordering and confirmation of order The bidder shall send the order acceptance within one week from the date of LOI/Purchase order or such other period as specified/agreed by the Buyer. Buyer reserves the right to revoke the order placed if the order confirmation differs from the original order placed. Buyer shall be legally bound, only if agreed for any deviation explicitly in writing. The acceptance of deliverables or supplies by Buyer as well as payments made in this regard shall not imply acceptance of any deviations. The Purchase order will be deemed to have been accepted if no communication to the contrary is received within one week (or the time limit as specified /agreed by the Buyer) from the date of P.O. Buyer, is at liberty to send signed P.O. through electronic media such as e-mail and the receipt of which shall be treated as receipt of order.
33	Execution The whole contract is to be executed in the most workman like manner, substantial and approved as per the contracted terms.
34	Progress Report The bidder shall render such report as to the progress of work and in such form as may be called for by the Buyer from time to time. The submission and acceptance of such reports shall not prejudice the rights of the buyer in any manner. Bidder shall communicate to BHEL immediately, the change of address, ownership, contact person(s), the mobile numbers and e-mail of the dealing person concerned. Milestones shall be periodically updated by bidder through PRADAN Portal (https://hpep.bhel.com/mm/). Non updation will adversely affect service rating of bidder performance.
35	Non-disclosure Obligations

**BHEL Enq No. D5A1X20339**

	<p>Drawings, technical documents or other technical information received by one party shall not without the consent of the other party, be used for any other purpose than that for which they were provided. They may not, without the consent of the submitting party, otherwise be used or copied, reproduced, transmitted or communicated to third parties. All information and data contained in general product documentation, whether in electronic or any other form, are confidential and binding only to the extent that they are by reference expressly included in the contract.</p> <p>The bidder shall, as per agreed date/s but not later than the date of delivery, provide free of charge any information and/or drawings which are necessary to permit the Buyer to erect, commission, operate and maintain the product. Such information and drawings shall be supplied as specified in technical specification.</p> <p>All intellectual properties, including designs, drawings and product information etc. exchanged during the formation and execution of the contract shall continue to be the property of the submitting party.</p> <p>The bidder shall provide Buyer with all information pertaining to the delivery in so far as it could be of importance to Buyer. The bidder shall not reveal confidential information to its own employees not involved with the tender/contract and its execution and delivery or to third parties, unless Buyer has agreed to this in writing beforehand. The bidder shall not be entitled to use the Buyer's name in advertisements and other commercial publications including website without prior written permission from Buyer.</p> <p>In the event of violation of the confidentiality as agreed, BHEL will take legal action as deemed fit. Non-disclosure agreement to be entered as per Annexure- II wherever applicable.</p>
36	Inspection and Testing
A	The goods and stores shall be manufactured by approved quality system and each part/component may be inspected and tested by the Buyer prior to shipment and shall comply with relevant requirements. Buyer has the right to inspect at any stage during manufacture/ delivery.
B	<p>Buyer or his authorized representative shall be entitled at all reasonable times during execution to inspect, examine and test at the bidder's premises the material and workmanship of all stores to be supplied under the contract, and if the part of the stores are being manufactured at other premises, the bidder shall obtain for buyer or his authorized representative permission to inspect, examine and test as if the said stores are being manufactured at the bidder's premises. Such inspection, examination and testing, if made shall not release the bidder from any obligation under the contract.</p> <p>For indigenous bidders all costs related to first inspection request shall be borne by the buyer and the cost of subsequent inspections due to non-readiness of material/rework/ rejections shall be borne by the bidder. In case of imports all inspection charges including third party inspections if any shall be borne by the bidder. The cost of inspection staff/third party specified by the Buyer shall be borne by bidder unless otherwise specifically agreed. If the contract provides for tests on the premises of the bidder or any of his sub-contractor/s, bidder shall be responsible to provide such assistance, labor, materials, electricity, fuels, stores, apparatus, instruments as may be required and as may be reasonably demanded to carry out such tests efficiently. Cost of any type test or such other special tests shall be borne by the bidder unless otherwise specifically agreed in the contract. The Bidder shall give the authorized representative of the buyer reasonable notice in writing of the date on and the place at which any stores will be ready for inspection/ testing as provided in the Contract. Annexure – I, may strictly be complied with for the time lines. Any delay in submission of the documents by the bidder will not alter the delivery date.</p>
37	Quality and Condition of the Deliverables
	The bidder shall be responsible for compliance with applicable technical, safety, quality, environmental requirements and other regulations in relation to products, packaging and raw and ancillary materials.
38	Packaging and Dispatch
	<p>The bidder shall package the deliverables safely and carefully and pack them suitably in all respects considering the peculiarity of the material for normal safe transport by sea/air/rail/road to its destination suitably protected against loss, damage, corrosion in transit and the effect of tropical salt laden atmosphere. The packages shall be provided with fixtures/hooks and sling marks as may be required for easy and safe handling by mechanical means. Special packaging conditions/ environmental conditions as defined in the NIT shall be fully complied.</p> <p>Each package must be marked with consignee name, address, P.O. number, Package Number, gross weight & net weight, dimensions (L x B x H) and bidder's name. The packing shall allow for easy removal and checking of goods on receipt and comply with carrier's conditions of packing or established trade practices. Packing list for goods inside each package with P.O. item No. & quantity must also be fixed securely outside the box to indicate the contents. If any consignment needs special handling instruction, the same shall be clearly marked with standard symbols/instructions. Hazardous material should be notified as such and their packing, transportation and other protection must conform to relevant regulations.</p>
39	Contract variations; Increase or decrease in the scope of supply
	<p>Buyer may vary the contracted scope during execution due to exigencies of project requirement.</p> <p>If the bidder is of the opinion that the variation has an effect on the agreed price or delivery period, Buyer shall be informed of this immediately in writing along with technical details, and in the event of additional work, submit a quotation with regards to the price and period involved, as well as the effect this additional work will have on the other work to be performed by the bidder. Wherever unit rates are available in the contract, the same shall be applied to such additional work. The bidder shall not perform additional work before buyer has issued written instructions/amendment to the purchase order to that effect. The work which the bidder should have or could have anticipated in terms of delivering the service (s) and functionality (ies) as described in this agreement should be executed by the bidder without any price implication.</p> <p>In case of no change in the scope / technical specifications, bidder shall endeavor to keep the material ready and intimate the same to BHEL within the contractual delivery date, failing which, the delay if any will be attributed to supplier, and any upward price variation thereof for delivery at a later date is not admissible.</p>
40	Rejected/Short shipments/ warranty/guarantee replacements
	In case of any short shipment during initial supply which is subsequently dispatched by the bidder or any guarantee / warranty replacements shall be dispatched on "DDP-Delivered duty paid BHEL stores" basis for imported items and "FOR-BHEL Stores/designated destination" basis for indigenous items.
41	Export Administration Regulations
	If a delivery includes such technology and / or supply that is subjected to the export regulations the bidder shall obtain due permissions, approvals, license etc.
42	Force Majeure

**BHEL Enq No. D5A1X20339**

	<p>The bidder shall not be considered in default if delay occurs due to causes beyond their control such as Acts of God, Natural calamities, Fire, Frost, Flood, Civil War, civil commotion, riot, Government Restrictions.</p> <p>Only those causes that have duration of more than seven days shall be considered cause of force majeure. Notification to this effect duly certified by local chamber of commerce/statutory authorities with supporting documents shall be given by the bidder to BHEL by registered letter/courier service immediately without loss of time.</p> <p>In the event of delay due to such causes the delivery schedule shall be extended for a length of time equal to the period of Force Majeure or at the option of BHEL the order may be cancelled. Such cancellation would be without any liability whatsoever on the part of BHEL.</p> <p>In the event of such cancellation the bidder shall refund any amount advanced or paid to the bidder by BHEL and deliver back any material issued to him by BHEL and release facilities, if any provided by BHEL.</p>
43	Non-waiver of Defaults
	If any individual provision of the contract is invalid, the other provisions shall not be affected.
44	Settlement of Disputes
	<p>Except as otherwise specifically provided in the contract, all disputes concerning questions of the facts arising under the contract, shall be decided by the Buyer, subject to written appeal by the bidder to the buyer, whose decision shall be final.</p> <p>Any disputes of differences shall to the extent possible be settled amicably between the parties thereto, failing which the disputed issues shall be settled through arbitration</p> <p>The bidder shall continue to perform the contract, pending settlement of disputes(s).</p>
45	Conciliation clause
	<p>CONCILIATION CLAUSE FOR CONDUCTING CONCILIATION PROCEEDINGS UNDER THE BHEL CONCILIATION SCHEME, 2018: The Parties agree that if at any time (whether before, during or after the arbitral or judicial proceedings), any Disputes (which term shall mean and include any dispute, difference, question or disagreement arising in connection with construction, meaning, operation, effect, interpretation or breach of the agreement, contract or the Memorandum of Understanding, penalty deduction, time extension), which the Parties are unable to settle mutually, arise inter-se the Parties, the same may, be referred by either party to Conciliation to be conducted through Independent Experts Committee to be appointed by competent authority of BHEL from the BHEL Panel of Conciliators.</p> <p>The proceedings of Conciliation shall broadly be governed by Part-III of the Arbitration and Conciliation Act 1996 or any statutory modification thereof and as provided in Procedure in http://www.bhel.com/index.php/story_details?story=2454 . The Procedure together with its Formats will be treated as if the same is part and parcel hereof and shall be as effectual as if set out herein in this ITB</p>
46	ARBITRATION (WITH SOLE ARBITRATOR)
	<p>Except as provided elsewhere in this Contract, in case amicable settlement is not reached between the Parties, in respect of any dispute or difference; arising out of the formation, breach, termination, penalty deduction, validity or execution of the Contract; time extension, or, the respective rights and liabilities of the Parties; or, in relation to interpretation of any provision of the Contract; or, in any manner touching upon the Contract, then, either Party may, by a notice in writing to the other Party refer such dispute or difference to the sole arbitration . Sole arbitrator to be appointed by Head of the Unit - BHEL , HPEP .</p> <p>The Arbitrator shall pass a reasoned award and the award of the Arbitrator shall be final and binding upon the Parties.</p> <p>Subject as aforesaid, the provisions of Arbitration and Conciliation Act 1996 (India) or statutory modifications or re-enactments thereof and the rules made thereunder and for the time being in force shall apply to the arbitration proceedings under this clause. The seat of arbitration shall be Sangareddy / Hyderabad, Telangana. The language of arbitration shall be English and the documents shall be submitted in English.</p> <p>The cost of arbitration shall initially be borne equally by the Parties subject to the final apportionment of the cost of the arbitration in the award of the Arbitrator.</p> <p>Subject to the arbitration in terms of clause 45, the courts at Sangareddy, Telangana State shall have exclusive jurisdiction over any matter arising out of or in connection with this contract.</p> <p>Notwithstanding the existence or any dispute or differences and/or reference for the arbitration, the Contractor shall proceed with and continue without hindrance the performance of its obligations under this Contract with due diligence and expedition in a professional manner except where the Contract has been terminated by either Party in terms of this Contract.</p>
	ARBITRATION FOR CONTRACT WITH PUBLIC SECTOR ENTERPRISE (PSE) OR A GOVERNMENT DEPARTMENT
	In the event of any dispute or difference relating to the interpretation and application of the provisions of commercial contract(s) between Central Public Sector Enterprises (CPSEs/ Port Trusts inter se and also between CPSEs and Government Departments/Organizations (excluding disputes concerning Railways, Income Tax, Customs & Excise Departments), such dispute or difference shall be taken up by either party for resolution through AMRCD as mentioned in DPE 0M No 4(1)/2013-DPE(GM/FTS 1835 dated 22-05-2018
47	Applicable Laws and jurisdiction of Courts
	This agreement shall be construed and interpreted in accordance with the laws of India and shall have exclusive jurisdiction of Sangareddy/Hyderabad courts, Telangana, India.
48	BHEL-Fraud prevention policy shall be adhered to.
	<p>The Bidder along with its associate/ Collaborators/ Sub-contractors/ sub-bidders/ consultants/ service providers shall strictly adhere to BHEL Fraud Prevention policy displayed on BHEL Website http://www.bhel.com and shall immediately bring to the notice of BHEL management about any fraud or suspected fraud as soon as it comes to their notice.</p> <p>List of nodal officers is hosted on BHEL Hyderabad website https://hpep.bhel.com/.</p>
49	Suspected Cartel Formation
	The Bidder declares that they will not enter into any illegal or undisclosed agreement or understanding, whether formal or informal with other Bidder(s). This applies in particular to prices, specifications, certifications, subsidiary contracts, submission or non-submission of bids or any other actions to restrict competitiveness or to introduce cartelization in the bidding process. In case , the Bidder is found having indulged in above activities, suitable action shall be taken by BHEL as per extant policies / guidelines .
50	Conflict of Interest:
	"A bidder shall not have conflict of interest with other bidders. Such conflict of interest can lead to anti-competitive practices to the detriment of Procuring Entity's interests. The bidder found to have a conflict of interest shall be disqualified. A bidder may be considered to have a conflict of interest with one or more parties in this bidding process, if:

**BHEL Enq No. D5A1X20339**

- a) they have controlling partner (s) in common; or
b) they receive or have received any direct or indirect subsidy/ financial stake from any of them; or
c) they have the same legal representative/agent for purposes of this bid; or
d) they have relationship with each other, directly or through common third parties, that puts them in a position to have access to information about or influence on the bid of another Bidder; or
e) Bidder participates in more than one bid in this bidding process. Participation by a Bidder in more than one Bid will result in the disqualification of all bids in which the parties are involved. However, this does not limit the inclusion of the components/ sub-assembly/ Assemblies from. one bidding manufacturer in more than one bid; or
f) In cases of agents quoting in offshore procurements, on behalf of their principal manufacturers, one agent cannot represent two manufacturers or quote on their behalf in a particular tender enquiry. One manufacturer can also authorize only one agent/dealer. There can be only one bid from the following:
1. The principal manufacturer directly or through one Indian agent on his behalf; and
2. Indian/foreign agent on behalf of only one principal; or
g) A Bidder or any of its affiliates participated as a consultant in the preparation of the design or technical specifications of the contract that is the subject of the Bid; or
h) In case of a holding company having more than one independently manufacturing units, or more than one unit having common business ownership/management, only one unit should quote. Similar restrictions would apply to closely related sister companies. Bidders must proactively declare such sister/ common business/ management units in same/ similar line of business. "

Note: Purchase officer has to fill Annexure-I while sending enquiry

Annexure-C

Breach of contract, remedies and termination

(A) Breach of contract and Termination:

Following conditions shall be considered as breach of contract:

- a) Non-supply of material/ non-completion of work by the vendor within scheduled delivery/ completion period as per contract or as extended from time to time.
- b) The vendor fails to perform as per the activity schedule and there are sufficient reasons even before expiry of the delivery/ completion period to justify that supplies shall be inordinately delayed beyond contractual delivery/ completion period.
- c) The vendor delivers equipment/ material not of the contracted quality.
- d) The vendor fails to replace the defective equipment/ material/ component as per guarantee clause.
- e) Withdrawal from or abandonment of the work by the vendor before completion as per contract.
- f) Assignment, transfer, subletting of Contract without BHEL's written permission resulting in termination of Contract or part thereof by BHEL.
- g) Non-compliance to any contractual condition or any other default attributable to Contractor/ Vendor.
- h) Termination of Contract on account of any other reason(s) attributable to Vendor.

In case of breach of contract, BHEL reserve the right to terminate the Purchase Order/ Contract either in whole or in part thereof without compensation to the vendor.

(B) Remedies for breach of contract:

In case of Breach of Contract, BHEL shall recover 10% amount of the contract value from the vendor in following manners:

- (i) 10% of the contract value shall be recovered from other financial remedies (i.e. available bills of the vendor, retention amount etc. with BHEL HPEP or any other units of BHEL.
- (ii) Demand notice for deposit of balance recovery amount shall sent to the vendor, if financial remedies are insufficient to affect the complete recovery.
- (iii) In case recovery is not possible from financial remedies mentioned above, legal remedies shall be pursued.

Notes:

In addition to aforementioned recovery for breach of contract, without prejudice to any other legal remedy, BHEL reserves its right to recover damages on account of levy of liquidated damages, debarment, termination, de-scoping, short-closure, etc as per applicable provisions of the contract.

Annexure-I

Major Activity timelines shall be considered for indigenous purchases

S No	Activity	Agency	Timeline
1	PO acknowledgement	Vendor	<u>7</u> days from PO
2	Submission of Drawings and QP	Vendor	<u>7</u> days from PO
3	Approval of Drawings and QP	BHEL / Customer	<u>15</u> days from PO
4	Raising of Final Inspection Call	Vendor	<u>15</u> days before PO delivery date.
5	Inspection completion	Self/BHEL/Third party inspection agency	<u>7</u> days from date of inspection proposed by vendor.
6	Dispatch Instructions	BHEL	<u>3</u> days from vendor request date after final inspection.

Vendor's Sign with seal.

(To be executed on Non- Judicial Stamp Paper for an appropriate value.
To be stamped as an agreement)

(For Suppliers on Unit's / Division's PMD)

ANNEXURE-II

Framework Confidentiality Agreement Cum Undertaking

This Agreement made on this the _____ day of (month) _____ 20 ____ (“Effective Date”) by and between M/s. BHARAT HEAVY ELECTRICALS LIMITED, having registered office at “BHEL House”, Siri Fort, New Delhi – 110049 (India), acting through its _____ Unit (hereinafter may be referred to as “BHEL” or “the company”).

And

M/s. _____ (address) _____
represented by authorized representative Sri _____ (herein after referred to as the “Supplier”).

The supplier and the company may, unless the context otherwise requires, hereinafter be collectively referred to as “Parties” or singly as the “Party”.

RECITALS

Whereas, BHEL is engaged in the design, engineering, manufacturing, construction, testing, commissioning and servicing of a wide range of products, systems and services for the core sectors of the economy, viz. Power, Transmission, Industry, Transportation, Renewable energy, Oil & Gas and Defence and providing associated services to varied customers in relation to which BHEL / its affiliates own valuable information of a secret and confidential nature.

Whereas the Company may, in connection with contract(s) (as defined hereunder) placed or to be placed upon the supplier, or otherwise, from time to time, make available, Technical Information as is defined hereunder.

And Whereas BHEL is willing to provide such Technical Information to the Supplier from time to time and the Supplier understands and acknowledges that such Technical Information is valuable for the Company and as such is willing to protect confidentiality of such information, subject to the terms and conditions set out hereunder.

Now therefore, in view of the foregoing premises and in consideration of the mutual covenants and agreements hereinafter set forth, the parties agree as under:

1. Definitions:

Unless the context so requires, in this Agreement, the following terms will bear the meaning ascribed to the said term in this clause.

- A. **“Contract”** means the contract entered into with a supplier and includes a Purchase Order, or a Work Order for procurement of any goods or for provision of any services.
- B. **“Effective Date”** means the date of this Agreement as mentioned in the preamble of this Agreement.
- C. **“Supplier”** includes a Contractor or a Vendor of the Company whether for supplying of goods or for providing any services under a Contract or both.
- D. **“Technical Information”** includes Drawings, and / or Product Standards and / or Specifications and / or Corporate / Plant Specifications and / or Technological Process Sheets and / or Technical Data Sheets and / or Jigs & Fixtures and / or Pattern & Dies and / or Special Gauges and / or Tools etc. Belonging to or wherein the Company has acquired from a third party a right of user and includes any improvement thereto from time to time whether carried out by the Company or by the Suppliers.
- E. **“Intended Purpose”** means the purpose for which the Technical Information is provided to the supplier under or in connection with a contract.
- F. **“Improvement”** includes any modification made to, or adaptation of, the Technical Information which enhances or is calculated to enhance the performance (Whether in terms of effectiveness or in terms of efficiency or both) of the product and / or the service to be provided by the Supplier under a Contract.

2. This Agreement shall come into force / deemed to have come into force, as the case may be, on the Effective Date; or, on the first date when the Technical Information or any part thereof is provided by BHEL to the supplier; whichever is earlier.

3. **Agreement deemed to be incorporated in each contract:** Unless and to the extent otherwise stipulated in the Contract, the conditions of this Agreement are deemed to be incorporated in all Contracts which may be entered into between the Company and the Supplier. Further, unless otherwise stipulated, the obligations under this Agreement are and will be independent of the obligations under the Contracts and such obligations of the Supplier hereunder will remain of full effect and validity notwithstanding that the period of validity of the Contract has expired by efflux of time stipulated therein; or, the contract has been discharged by performance or breach; or, the termination of the Contracts for any reason whatsoever.

4. **Ownership:**

4.1 The Company may, from time to time, make available to the Supplier, Technical Information on a non-exclusive basis by way of loan.

4.2 The Supplier acknowledges and agrees that all Technical Information and copies thereof that are or may be provided by the Company to the Supplier, are and shall remain the property of

BHEL or that of the concerned entity from whom BHEL has obtained the Technical Information and such Technical Information are and shall constitute trade secrets of the BHEL. Nothing in this Agreement or in any disclosures made hereunder by or on behalf of the Company shall be construed as granting upon the Supplier any patent, copyright or design or any other intellectual property rights of whatsoever description that subsists or may hereinafter exist in the Technical Information. Furthermore, nothing in this Agreement or in any disclosures made hereunder by or on behalf of the Company shall be construed as granting upon the supplier any license or right of use of such patent, copyright or design or any other intellectual property rights of whatsoever description which may now or hereafter exist in the Technical Information except for use of the Technical Information strictly in accordance with this Agreement and the contract and / or as directed in writing by the Company, solely for the Intended Purpose under the Contract.

4.3 Neither party is obligated by or under this Agreement to purchase from or provide to the other party any service or product and that any such purchase / sale of any product and / or service by one party to the other party will be governed by the Contract if any, that may be entered into by and between the Company and the Supplier.

4.4 The Supplier is / has been made well aware and acknowledges that the Technical Information being / which may be shared with it by the Company has been either generated by the Company by incurring huge investment and cost or obtained from foreign collaborators under Technical Collaboration Agreement (TCA) with stringent confidentiality conditions.

4.5 The supplier agrees and undertakes to adhere to confidentiality requirements as applicable to BHEL under a TCA and also ensure that the confidentiality requirements are adhered to by all its concerned employees or sub-contractors /suppliers (where permitted to be engaged by BHEL). Any damages, losses, expenses of any description whatsoever, arising out of or in connection with a breach of the confidentiality requirements under a TCA owing to any act or omission on the part of the supplier or its employees or sub-contractors / suppliers that is claimed by a foreign collaborator from the Company shall be wholly borne by the Supplier and it shall keep BHEL fully indemnified in this behalf. The demand by the Company shall be conclusive upon the Supplier who shall thereupon forthwith pay to the Company without demur, dispute or delay the amount as demanded without demanding any further proof thereof.

4.6 The Supplier agrees and undertakes that unless so decided and advised by the Company in writing all rights / title to any Improvement to the Technical Information shall vest in the Company. The Supplier undertakes and agrees to inform forthwith to the Company of any such Improvement made to the Technical Information and transfer all drawings / documents or other materials connected with such Improvement to the Company and also agrees to fully cooperate with the Company for protecting the Company's interests in such Improvements

in the Technical Information including but not limited to obtaining necessary protection for the intellectual property rights in such improvement, if so desired by the Company. If a question arises whether a modification amounts to improvement to the Technical Information, the same shall be decided by the Company and such decision shall be final and binding upon the supplier.

5. Use and Non – Disclosure:

5.1 Unless otherwise stipulated by the Company, all Technical Information made available to the supplier, by the Company shall be treated as Confidential irrespective of whether the same is marked or otherwise denoted to be Confidential or not.

5.2 The Supplier undertakes and agrees that the Technical Information in its possession shall be held in strict confidence and will be used strictly in accordance with this Agreement and solely for the Intended Purpose under the Contract. Use of the Technical Information for any other purpose other than Intended Purpose is prohibited.

5.3 In particular, the Supplier shall not use Technical Information or any Improvement in its possession for the manufacture or procurement of the product(s) or components or parts thereof or use the Technical Information or any portion thereof or any modification or adaptation thereof in any form to provide any product and / or service to any third party, without the prior written consent of the Company.

5.4 The Supplier shall not disclose any of such Technical Information to any third party without the prior written consent of the Company. The Supplier agrees that without prior written consent of the Company, the supplier shall not disclose to a third party about the existence of this Agreement, or of the fact that it is / was in possession of or has experience in the use of any Technical Information nor shall the Supplier share in any manner whatsoever, with a third party, the name or details of any Contract(s) awarded by the Company to it or performed by the Supplier or the scope of work thereof or share any document or correspondence by and between the Company and the supplier in or in connection with this Agreement or such Contract(s). Notwithstanding what is stated elsewhere, the overall responsibility of any breach of the confidentiality provisions under this Agreement shall rest with the Supplier.

5.5 This Supplier undertakes and agrees not to make copies or extracts of and not to disclose to other any or all of the Technical Information in its possession, except as follows:

(a) The Supplier may disclose the Technical Information to such of its officers and employees strictly to the extent as is necessary for such officer or employee for the Intended Purpose, provided that the Confidential Information (or copies thereof) disclosed shall be marked

clearly as the confidential and proprietary information of Company and that such officers and employees shall similarly be bound by undertakings of confidence, restricted use and non-disclosure in respect of the Technical Information. The Supplier shall be responsible for any breach of such confidentiality provisions by such officers and employees.

- (b) With the prior written consent of Company, the supplier may disclose for the Intended Purpose such Technical Information as is provided for in such consent to such of its professional advisers: consultants, insurers and subcontractors who shall be similarly bound by undertakings of confidence, restricted use and non-disclosure in respect of such Technical Information.
- (c) The Supplier shall not be prevented to make any disclosure required by (i) order of a court of competent jurisdiction or (ii) any competent regulatory authority or agency where such disclosure is required by law, provided that where the supplier intends to make such disclosure, it shall first consult Company and take all reasonable steps requested by it to minimize the extent of the Technical Information disclosed and to make such disclosure in confidence and also shall cooperate with the Company in seeking any protective order or any other remedy from proper authority in this matter.

6. Exceptions:

The Obligations of the Supplier pursuant to the provisions of this agreement shall not apply to any Confidential Information that:

- a) was / is known to, or in the possession of the Supplier prior to disclosure thereof by the Company;
- b) is or becomes publicly known, otherwise than as a result of a breach of this agreement by the Supplier.
- c) is developed independently of the Disclosing party by the Supplier in circumstances that do not amount to a breach of the provisions of this Agreement or the Contract;
- d) is received from a third party in circumstances that do not result in a breach of the provisions of this Agreement.

- 7. The Obligation of maintaining confidentiality of the Technical Information on each occasion, shall subsist for the entire duration during which the Technical Information / equipment is in possession of the Supplier and shall thereafter subsist for a further period of _____ years from the date when the complete Technical Information has been returned in portions on different dates, the period of ____ years will be reckoned from the date when the last portion of the Technical Information has been returned. Notwithstanding the expiry of the confidentiality obligation, the obligation of the Supplier under clause 5.4 shall continue to subsist for a further period of _____ years.

8. Warranties & Undertakings:

- a) The Supplier undertakes to ensure the due observance of the undertakings of confidence, restricted use and non-disclosure by its persons to whom it discloses or releases copies or extracts of the Technical Information.
- b) The Supplier shall keep the Technical Information or improvement made therein properly segregated and not mix up the same with any other material / documents belonging to him / it or to any other third party.
- c) The Supplier further undertakes that he / it shall not hypothecate or give on lease or otherwise alienate or do away with any of the Technical Information and / or equipment of the Company, made available to him / it, and undertakes that he / it shall hold the same as a trustee, in capacity of custodian thereof and use / utilise the same solely for the purpose of executing the contract awarded by the Company.
- d) The Supplier further undertakes that he / it shall return all the equipment and / or Technical Information as far as practicable in the same condition in which the same was made available to him / it by the Company together with any Improvement thereon and the documents connected with such Improvement, to the Company forthwith upon completion of the scope of work or contract for which such Technical Information was provided by the Company to it or as directed by the Company together with a confirmation by way of an affidavit or in such manner as directed by the Company that it has not retained any equipment and / or Technical Information / improvement thereof. In case any such equipment and / or Technical Information or thereof shall remain in his possession or is not capable of being returned, the retention and use of such Technical Information or improvement thereto shall continue to be governed by this Agreement.
- e) The Supplier undertakes to indemnify the Company for all the direct, indirect and / or consequential losses, damages, expenses whatsoever including any consequential loss of business, profits suffered by the Company owing to breach by the Supplier of its obligations under this Agreement and / or the confidentiality requirements, if any, contained in the Contract and that the Supplier hereby agrees that the decision of the Company in all such or any such matter/s shall be final and binding on the Supplier. On mere written demand of the Company, the Supplier shall forthwith and without demur or delay pay to the Company any such sum as determined by the Company as the amount of loss or damage or expense which has been suffered by the Company. The Supplier agrees that the Company shall be entitled to withhold and appropriate any amount payable to the Supplier under any Contract then existing between the Company and the Supplier, in case the Supplier fails to make payment, in terms of the written demand, within 7 days thereof. Without prejudice to the forgoing actions, in respect to any breach of this Agreement, the Company shall be entitled to take

any other action against the Supplier as per applicable laws, the Contract, Company's applicable policies, guidelines rules, procedures, etc.

9. Without prejudice to any other mode of recovery as may be available to the Company for recovery of the amount determined as due as per Clause 9 (f) hereinabove, the Company shall have a right to withhold, recovery and appropriate the amount due towards such losses, damages, expenses, from any amount due to the Supplier in respect of any other Contract (s) placed on him / it by any department / office / unit/ division of the said Company.

10. Arbitration & Conciliation:

Except as provided elsewhere in this Contract, in case amicable settlement is not reached between the Parties, in respect of any dispute or difference; arising out of the formation, breach, termination, penalty deduction, validity or execution of the Contract; time extension, or, the respective rights and liabilities of the Parties; or, in relation to interpretation of any provision of the Contract; or, in any manner touching upon the Contract, then, either Party may, by a notice in writing to the other Party refer such dispute or difference to the sole arbitration . Sole arbitrator to be appointed by Head of the Unit - BHEL, HPEP.

The Arbitrator shall pass a reasoned award and the award of the Arbitrator shall be final and binding upon the Parties.

Subject as aforesaid, the provisions of Arbitration and Conciliation Act 1996 (India) or statutory modifications or re-enactments thereof and the rules made thereunder and for the time being in force shall apply to the arbitration proceedings under this clause.

The seat of arbitration shall be Sangareddy / Hyderabad, Telangana. The language of arbitration shall be English and the documents shall be submitted in English.

The cost of arbitration shall initially be borne equally by the Parties subject to the final apportionment of the cost of the arbitration in the award of the Arbitrator.

Subject to the arbitration in terms of clause 46 of ITB (clause 27 of ATC GeM), the courts at Sangareddy, Telangana State shall have exclusive jurisdiction over any matter arising out of or in connection with this contract.

Notwithstanding the existence or any dispute or differences and/or reference for the arbitration, the Contractor shall proceed with and continue without hindrance the performance of its obligations under this Contract with due diligence and expedition in a professional manner except where the Contract has been terminated by either Party in terms of this Contract.

ARBITRATION FOR CONTRACT WITH PUBLIC SECTOR ENTERPRISE (PSE) OR A GOVERNMENT DEPARTMENT

In the event of any dispute or difference relating to the interpretation and application of the provisions of commercial contract(s) between Central Public Sector Enterprises (CPSEs/ Port Trusts inter se and also between CPSEs and Government Departments/Organizations (excluding disputes concerning Railways, Income Tax, Customs & Excise Departments), such dispute or difference shall be taken up by either party for resolution through AMRCD as mentioned in DPE OM No 4(1)/2013-DPE(GM/FTS 1835 dated 22-05-2018

CONCILIATION CLAUSE FOR CONDUCTING CONCILIATION PROCEEDINGS UNDER THE BHEL CONCILIATION SCHEME, 2018: The Parties agree that if at any time (whether before, during or after the arbitral or judicial proceedings), any Disputes (which term shall mean and include any dispute, difference, question or disagreement arising in connection with construction, meaning, operation, effect, interpretation or breach of the agreement, contract or the Memorandum of Understanding, penalty deduction, time extension), which the Parties are unable to settle mutually, arise inter-se the Parties, the same may, be referred by either party to Conciliation to be conducted through Independent Experts Committee to be appointed by competent authority of BHEL from the BHEL Panel of Conciliators.

The proceedings of Conciliation shall broadly be governed by Part-III of the Arbitration and Conciliation Act 1996 or any statutory modification thereof and as provided in Procedure in http://www.bhel.com/index.php/story_details?story=2454 . The Procedure together with its Formats will be treated as if the same is part and parcel hereof and shall be as effectual as if set out herein in this ITB

11. Governing Law & Jurisdiction:

This agreement shall be construed and interpreted in accordance with the laws of India and shall have exclusive jurisdiction of Sangareddy/Hyderabad courts, Telangana, India.

SIGNATURE

WITNESSES

1

Name:

Address:

2

Name:

Address:

Annexure - III

Proforma for self-certification by Supplier for minimum local content on their letter head for tender value less than Rs 10 Crore

"We _____ (Name of Manufacturer) undertake that we meet the mandatory minimum Local Content (LC) requirement i.e. _____ (to be filled as notified in the policy) for claiming Purchase Preference linked with Local Contents under the Govt. policy against tender no. _____."

Annexure - IV

Proforma for self-certification by Supplier for Compliance to Clause No 20 (B)

I have read the clause regarding restrictions on procurement from a bidder of a country which shares a land border with India and I certify that M/s.... (Name of firm) is **not from such a country/is from such a country** (delete whichever is NOT applicable) and has been duly registered with the Competent authority (delete if NOT applicable) . I hereby certify M/s fulfills all requirements in this regard and is eligible to be considered . (where applicable , valid registration by the competent authority shall be attached)

Sd/-

Authorised Signatory with Stamp

PRE-QUALIFICATION CRITERIA		Document no: HE-HEC-TIFORGMED REV.00 Dt: 27.12.23		
Titanium Forgings (Medium)				
S.No.	BHEL Requirement	Vendor's Confirmation	Deviation if Any	Remarks
	Offer from either Original Manufacturer or Dealer (who is having valid authorization certificate from Original Manufacturer)			
1	All the suppliers need to submit this document i.e. titled pre-qualification criteria and furnish required information along with the offer.			
2	Name, address, e-mail id, contact no.etc. of manufacturing unit.			
3	Supplier to confirm/provide the following criteria/documents for evaluation of offer.			
	(a) The supplier should have the proven experience in manufacturing and supply of min. 450 mm ID and 30 mm (min thk.) forgings for use in Pressure vessels & Heat Exchangers.			
	i) Material of construction : Titanium SB-381 (Any Grade) as per ASME Sec-II, Part-B			
	ii) All the facilities required for manufacturing shall be readily available at suppliers works.			
	iii) Item shall not be manufactured from MELTED OUT SCRAP TITANIUM.			
	All the above criteria 3(a) (i) to 3(a) (iii) must be combinedly met by the vendor against a single supply reference.			
	(b) The supplier meeting all the above criteria as 3 (a) (i) to 3 (a) (iii) shall furnish details of such supplies that meets the criteria in (sl no 3 (a)). (i) Purchase order copy in case the vendor is not in the BHEL Product material directory for the mentioned item. (ii) Vendors who are part of BHEL product material directory (excluding those who are in the barred or hold list) are exempted from submitting the previous order execution details. (or) any other document which provides the above details. All the documents shall be furnished only in English. Documents furnished in other language will not be considered for further evaluation.			
	(c) BHEL reserves the right to cross verify with the above such customers including overseas customers and satisfy itself with reference to the claims of the supplier. If the information furnished by the supplier is not found satisfactory, the offer will be technically rejected.			
4	Offers without the requirement as above 3(a) & 3(b) shall not be technically evaluated by BHEL. Further, no correspondence in this matter will be entertained.			
5	Material shall be sourced from reputed sources. Name of the sources from whom the Materials are sourced may be furnished for reference.			
6	List of BHEL qualified bidders may be forwarded to BHEL's End Customer for their review and approval. The list finalized by BHEL's End Customer shall be final and binding on vendor.			
7	BHEL team may carry out vendor evaluation/assessment(in case of a new vendor)by a visit to vendor works for qualifying /rejecting the technical bid based on the findings of the visit.			

8	Vendors to submit their bid in 2- part system i.e. Part-I shall consists of Pre-Qualification Criteria along with the required documents and Techno-Commercial Bid and Part-II shall consists of Price Bid. Offers failing to meet prequalification part will not be considered for further evaluation.			
---	---	--	--	--

PRE-QUALIFICATION CRITERIA		Document no: HE-HEC-TIFORGSML REV.00 Dt: 20.01.24		
Titanium Forgings (Small)				
S.No.	BHEL Requirement	Vendor's Confirmation	Deviation if Any	Remarks
	Offer from either Original Manufacturer or Dealer (who is having valid authorization certificate from Original Manufacturer)			
1	All the suppliers need to submit this document i.e. titled pre-qualification criteria and furnish required information along with the offer.			
2	Name, address, e-mail id, contact no.etc. of manufacturing unit.			
3	Supplier to confirm/provide the following criteria/documents for evaluation of offer.			
	(a) The supplier should have the proven experience in manufacturing and supply of min. 90 mm ID and 10 mm (min thk.) forgings for use in Pressure vessels & Heat Exchangers.			
	i) Material of construction : Titanium SB-381 (Any Grade) as per ASME Sec-II, Part-B			
	ii) All the facilities required for manufacturing shall be readily available at suppliers works.			
	iii) Item shall not be manufactured from MELTED OUT SCRAP TITANIUM.			
	All the above criteria 3(a) (i) to 3(a) (iii) must be combinedly met by the vendor against a single supply reference.			
	(b) The supplier meeting all the above criteria as 3 (a) (i) to 3 (a) (iii) shall furnish details of such supplies that meets the criteria in (sl no 3 (a)). (i) Purchase order copy in case the vendor is not in the BHEL Product material directory for the mentioned item. (ii) Vendors who are part of BHEL product material directory (excluding those who are in the barred or hold list) are exempted from submitting the previous order execution details. (or) any other document which provides the above details. All the documents shall be furnished only in English. Documents furnished in other language will not be considered for further evaluation.			
	(c) BHEL reserves the right to cross verify with the above such customers including overseas customers and satisfy itself with reference to the claims of the supplier. If the information furnished by the supplier is not found satisfactory, the offer will be technically rejected.			
4	Offers without the requirement as above 3(a) & 3(b) shall not be technically evaluated by BHEL. Further, no correspondence in this matter will be entertained.			
5	Material shall be sourced from reputed sources. Name of the sources from whom the Materials are sourced may be furnished for reference.			
6	List of BHEL qualified bidders may be forwarded to BHEL's End Customer for their review and approval. The list finalized by BHEL's End Customer shall be final and binding on vendor.			
7	BHEL team may carry out vendor evaluation/assessment(in case of a new vendor)by a visit to vendor works for qualifying /rejecting the technical bid based on the findings of the visit.			

8	Vendors to submit their bid in 2- part system i.e. Part-I shall consists of Pre-Qualification Criteria along with the required documents and Techno-Commercial Bid and Part-II shall consists of Price Bid. Offers failing to meet prequalification part will not be considered for further evaluation.			
---	---	--	--	--

FIRST ANGLE PROJECTION

(ALL DIMENSIONS ARE IN mm)

INVENTORY NO. SIGN. AND DATE T REF. DRG. NO. THE INFORMATION ON THIS DOCUMENT IS THE PROPERTY OF BHARAT HEAVY ELECTRICALS LIMITED. IT MUST NOT BE USED DIRECTLY OR INDIRECTLY IN ANY WAY DETRIMENTAL TO THE INTEREST OF THE COMPANY

REV.	DATE	ALTERED	CHECKED	APPD	REV.	DATE	ALTERED	CHECKED	APPD	ADDITIONAL INFORMATION
										STATUS OF DRAWING
										DISTURIBUTION OF PRINTS

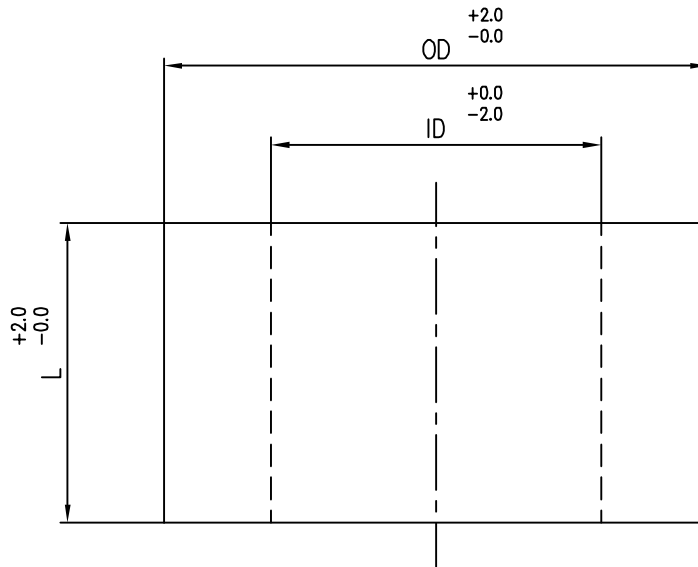

VAR.NO.	ID	OD	L	Wt (Kg)	MAT-CODE	MATL DESCRIPTION
01	895	1020	260	220.5	HE9715004997	CW INLET NOZZLE FORGING (SB-381 GR.F3)
02	895	1020	350	296.8	HE9715004989	CW OUTLET NOZZLE FORGING (SB-381 GR.F3)

NOTES

1. ALL DIMENSIONS ARE IN MM UNLESS OTHERWISE SPECIFIED.
2. POSITIVE MATERIAL IDENTIFICATION & CHEMICAL ANALYSIS SHALL BE REPORTED.
3. MATERIAL SHALL CONFIRM TO SB 381 GR.F3 OF ASME SEC-II PART-B EDITION AS PER PR/PO.
4. ALL CLAUSES OF SB 381 GR.F3 SHALL BE STRICTLY ADHERED TO.
5. HEAT TREATMENT - ANNEALING SHALL BE CARRIED OUT.
6. UT SHALL BE CARRIED OUT AS PER 3.6.3 OF ASME SECTION VIII DIV.2 EDITION AS PER PR/PO.
7. LIQUID PENETRANT TEST SHALL BE CARRIED OUT AS PER 3.6.4 OF ASME SECTION VIII DIV.2 EDITION AS PER PR/PO.
8. TEST COUPON SHALL BE TAKEN AS PER 3.10.4.2 OF ASME SECTION VIII DIV.2 EDITION AS PER PR/PO.
9. MARKING AND CERTIFICATION SHALL BE AS PER SB 381 ASME SECTION II PART B EDITION AS PER PR/PO.

ITEM NO	DESCRIPTION	DRAWING NO.	MATL. CODE	UNIT Wt. (KG)
			MATL. SPEN.	QTY.



BHARAT HEAVY ELECTRICALS LTD.
HYDERABAD

DRN.	NAME	SIGN.	DATE	NO.OF VAR.
	SIVA	S.P.J	19.12.23	
CHD.	UMESH	<i>Umesh</i>	19.12.23	NA
APPD.	KIRAN	<i>Kiran</i>	19.12.23	

DEPT. HE	GRADE OF TOL.DIM. $\frac{L}{M}/\frac{P}{F}$		SCALE NTS	WEIGHT (KG) -	REF. TO ASSY DRG. NA	ITEM NO.	NO.OF ITEMS NA
----------	---	--	-----------	---------------	----------------------	----------	----------------

TITLE TITANIUM NOZZLE FORGINGS	CARD CODE	DRAWING NO. 4-16010-09715	REV. 00
SHEET NO. 1		NO OF SHEETS 1	

FIRST ANGLE PROJECTION

(ALL DIMENSIONS ARE IN mm)

INVENTORY NO. SIGN. AND DATE REF. DRG. NO. THE INFORMATION ON THIS DOCUMENT IS THE PROPERTY OF BHARAT HEAVY ELECTRICALS LIMITED. IT MUST NOT BE USED DIRECTLY OR INDIRECTLY IN ANY WAY DETRIMENTAL TO THE INTEREST OF THE COMPANY

REV.	DATE	ALTERED	CHECKED	APPD	REV.	DATE	ALTERED	CHECKED	APPD	ADDITIONAL INFORMATION
										STATUS OF DRAWING
										DISTURIBUTION OF PRINTS

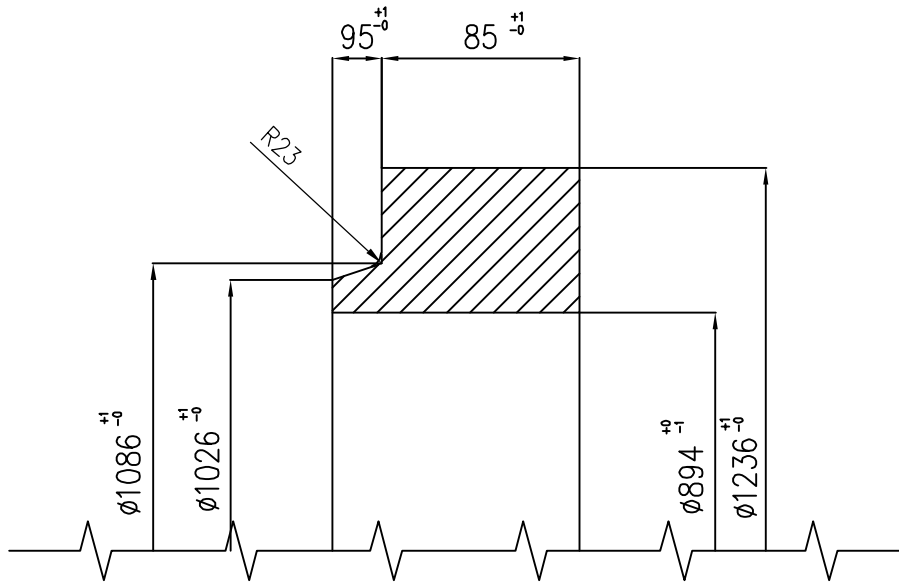

NOTES

1. ALL DIMENSIONS ARE IN MM UNLESS OTHERWISE SPECIFIED.
2. POSITIVE MATERIAL IDENTIFICATION & CHEMICAL ANALYSIS SHALL BE REPORTED.
3. MATERIAL SHALL CONFIRM TO SB 381 GR.F3 OF ASME SEC-II PART-B EDITION AS PER PR/PO.
4. ALL CLAUSES OF SB 381 GR.F3 SHALL BE STRICTLY ADHERED TO.
5. HEAT TREATMENT - ANNEALING SHALL BE CARRIED OUT.
6. UT SHALL BE CARRIED OUT AS PER CLAUSE 3.6.3 OF ASME SECTION VIII DIV.2 EDITION AS PER PR/PO.
7. LIQUID PENETRANT TEST SHALL BE CARRIED OUT AS PER 3.6.4 OF ASME SECTION VIII DIV.2 EDITION AS PER PR/PO.
8. TEST COUPON SHALL BE TAKEN AS PER 3.10.4.2 OF ASME SECTION VIII DIV.2 EDITION AS PER PR/PO.
9. MARKING AND CERTIFICATION SHALL BE AS PER SB 381 ASME SECTION II PART B EDITION AS PER PR/PO.

ITEM NO.	DESCRIPTION	DRAWING NO.	MATL. CODE	UNIT Wt. (KG)
			MATL. SPEN.	QTY.



BHARAT HEAVY ELECTRICALS LTD.
HYDERABAD

DRN.	NAME	SIGN.	DATE	NO. OF VAR.
	SIVA	S.P.J	29.11.23	
CHD.	UMESH	<i>Umesh</i>	29.11.23	NA
APPD.	KIRAN	<i>Kiran</i>	29.11.23	

DEPT. HE	GRADE OF TOL. DIM. $\frac{E}{M/F}$	SCALE NTS	WEIGHT (KG) ~326	REF. TO ASSY DRG. NA	ITEM NO.	NO. OF ITEMS NA
----------	------------------------------------	-----------	------------------	----------------------	----------	-----------------

TITLE CW TITANIUM FLANGE FORGING	CARD CODE	DRAWING NO. 4-16010-09716	REV. 00
SHEET NO. 1		NO OF SHEETS 1	

FIRST ANGLE PROJECTION

(ALL DIMENSIONS ARE IN mm)

INVENTORY NO. SIGN. AND DATE T REF. DRG. NO. THE INFORMATION ON THIS DOCUMENT IS THE PROPERTY OF BHARAT HEAVY ELECTRICALS LIMITED. IT MUST NOT BE USED DIRECTLY OR INDIRECTLY IN ANY WAY DETRIMENTAL TO THE INTEREST OF THE COMPANY

REV.	DATE	ALTERED	CHECKED	APPD	REV.	DATE	ALTERED	CHECKED	APPD	ADDITIONAL INFORMATION
										STATUS OF DRAWING
										DISTURIBUTION OF PRINTS

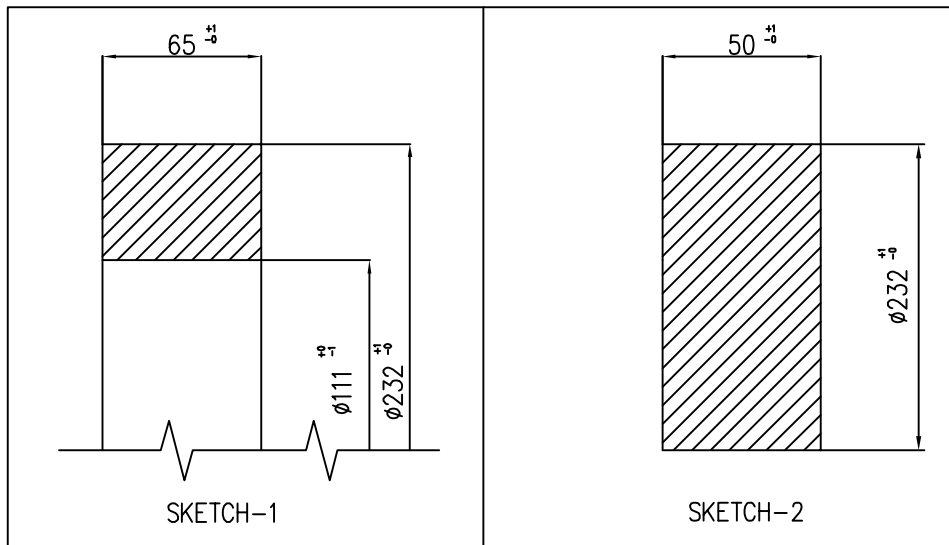

VAR.NO.	ID	OD	THK	Wt (Kg)	MAT-CODE	MATL. DESCRIPTION	FIG.
01	111	232	65	9.55	HE9715004962	4" DRAIN NOZZLE FLANGE (SB-381 GR.F3)	SKETCH-1
02	-	232	50	9.53	HE9712454541	DRAIN CONN.BLIND FLANGE (SB-381 GR.F3)	SKETCH-2

NOTES

1. ALL DIMENSIONS ARE IN MM UNLESS OTHERWISE SPECIFIED.
2. POSITIVE MATERIAL IDENTIFICATION & CHEMICAL ANALYSIS SHALL BE REPORTED.
3. MATERIAL SHALL CONFIRM TO SB 381 GR.F3 OF ASME SEC-II PART-B EDITION AS PER PR/PO.
4. ALL CLAUSES OF SB 381 GR.F3 SHALL BE STRICTLY ADHERED TO.
5. HEAT TREATMENT - ANNEALING SHALL BE CARRIED OUT.
6. UT SHALL BE CARRIED OUT AS PER 3.6.3 OF ASME SECTION VIII DIV.2 EDITION AS PER PR/PO.
7. LIQUID PENETRANT TEST SHALL BE CARRIED OUT AS PER 3.6.4 OF ASME SECTION VIII DIV.2 EDITION AS PER PR/PO.
8. TEST COUPON SHALL BE TAKEN AS PER 3.10.4.2 OF ASME SECTION VIII DIV.2 EDITION AS PER PR/PO.
9. MARKING AND CERTIFICATION SHALL BE AS PER SB 381 ASME SECTION II PART B EDITION AS PER PR/PO.

ITEM NO	DESCRIPTION	DRAWING NO.	MATL. CODE	UNIT Wt. (KG)
			MATL. SPEN.	QTY.



BHARAT HEAVY ELECTRICALS LTD.
HYDERABAD

DRN.	NAME	SIGN.	DATE	NO.OF VAR.
	SIVA	S.P.J	29.11.23	
CHD.	UMESH	<i>[Signature]</i>	29.11.23	NA
APPD.	KIRAN	<i>[Signature]</i>	29.11.23	

DEPT. HE	GRADE OF TOL.DIM. E/M/F		SCALE NTS	WEIGHT (KG) ~1823	REF. TO ASSY DRG. NA	ITEM NO.	NO.OF ITEMS NA
----------	-------------------------	--	-----------	-------------------	----------------------	----------	----------------

TITLE TITANIUM FLANGE FORGINGS	CARD CODE	DRAWING NO. 4-16010-09718	REV. 00
SHEET NO. 1		NO OF SHEETS 1	

FIRST ANGLE PROJECTION

(ALL DIMENSIONS ARE IN mm)

INVENTORY NO. SIGN. AND DATE T REF. DRG. NO. THE INFORMATION ON THIS DOCUMENT IS THE PROPERTY OF BHARAT HEAVY ELECTRICALS LIMITED. IT MUST NOT BE USED DIRECTLY OR INDIRECTLY IN ANY WAY DETRIMENTAL TO THE INTEREST OF THE COMPANY

REV.	DATE	ALTERED	CHECKED	APPD	REV.	DATE	ALTERED	CHECKED	APPD	ADDITIONAL INFORMATION
										STATUS OF DRAWING
										DISTURIBUTION OF PRINTS

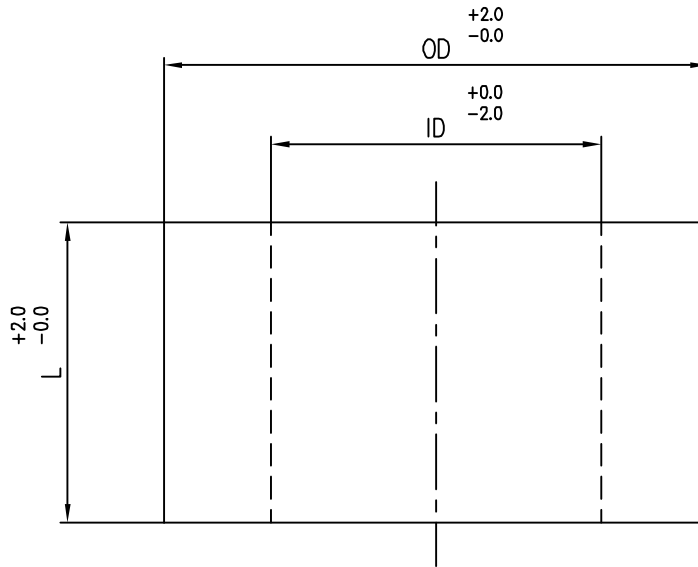

SL.No	ID	OD	L	Wt (Kg)	MAT-CODE	MATL DESCRIPTION
01	92	114.3	335	5.4	HE9715004970	4" DRAIN NOZZLE FORGING (SB-381 GR.F3)

NOTES

1. ALL DIMENSIONS ARE IN MM UNLESS OTHERWISE SPECIFIED.
2. POSITIVE MATERIAL IDENTIFICATION & CHEMICAL ANALYSIS SHALL BE REPORTED.
3. MATERIAL SHALL CONFIRM TO SB 381 GR.F3 OF ASME SEC-II PART-B EDITION AS PER PR/PO.
4. ALL CLAUSES OF SB 381 GR.F3 SHALL BE STRICTLY ADHERED TO.
5. HEAT TREATMENT - ANNEALING SHALL BE CARRIED OUT.
6. UT SHALL BE CARRIED OUT AS PER 3.6.3 OF ASME SECTION VIII DIV.2 EDITION AS PER PR/PO.
7. LIQUID PENETRANT TEST SHALL BE CARRIED OUT AS PER 3.6.4 OF ASME SECTION VIII DIV.2 EDITION AS PER PR/PO.
8. MECHANICAL PROPERTIES FOR THE MATERIAL SHALL BE PROVEN ON TEST SPECIMEN/COUPON AS PER SB-381 OF ASME SEC-II PART-B EDITION AS PER PR/PO.
9. MARKING AND CERTIFICATION SHALL BE AS PER SB 381 ASME SECTION II PART B EDITION AS PER PR/PO.

ITEM NO	DESCRIPTION	DRAWING NO.	MATL. CODE	UNIT Wt. (KG)
			MATL. SPEN.	QTY.



BHARAT HEAVY ELECTRICALS LTD.
HYDERABAD



	NAME	SIGN.	DATE	NO.OF VAR.
DRN.	SIVA	S.P.J	19.12.23	
CHD.	UMESH	<i>[Signature]</i>	19.12.23	NA
APPD.	KIRAN	<i>[Signature]</i>	19.12.23	

DEPT. HE	GRADE OF TOL.DIM. E/M/F		SCALE NTS	WEIGHT (KG) -	REF. TO ASSY DRG. NA	ITEM NO.	NO.OF ITEMS NA
----------	-------------------------	--	-----------	---------------	----------------------	----------	----------------

TITLE TITANIUM PIPE FORGING (4")	CARD CODE	DRAWING NO. 4-16010-09728	REV. 00
SHEET NO. 1		NO OF SHEETS 1	

		BHARAT HEAVY ELECTRICALS LIMITED R.C.PURAM, HYDERABAD		STANDARD QUALITY PLAN FOR VENDOR ITEMS				QP. NO: HYQA/VSQP/2023-24/1032006900/303 REV. NO.: 00 DATE: 25.09.2023 PAGE 1 OF 2					
				ITEM: TITANIUM FORGING BHEL SPEC: NA BHEL DRG: as per PO				FORMAT OF RECORD	*D	AGENCY			REMARKS
SL NO	COMPONENT/ OPERATIONS	CHARACTERISTICS	CLASS	TYPE OF CHECK	QUANTUM OF CHECK	REF DOCUMENT	ACCEPTANCE NORMS	FORMAT OF RECORD	*D	P	W	V	REMARKS



1.0 RAW MATERIALS & BOUGHT OUT ITEMS													
1.1	FORGING	VERIFICATION OF MILL TC (INGOTS/BLOOMS) CHEM. & MECH. PROPERTIES	CRITICAL	VISUAL	100%	MATERIAL GRADE AS PER DRG SB 381 GR F3	SUPPLIER'S TC	✓	2				
1.2		PRODUCT ANALYSIS	MAJOR	CHEM	100%	MATERIAL GRADE AS PER DRG SB 381 GR F3	SUPPLIER'S TC	✓	2			1	
1.3		PMI	MAJOR	GRADE	100%	MATERIAL GRADE AS PER DRG SB 381 GR F3	SUPPLIER'S TC	✓	2	1			
1.4		VERIFICATION OF HT CHART	MAJOR	HT	100 %	MATERIAL GRADE AS PER DRG SB 381 GR F3	HT CHART	✓	2			1	
1.5		UT EXAM.	MAJOR	NDE	100%	CL 3.6.3 ASME SEC VIII DIV2	NDE REPORT	✓	2	1			
1.6		PT	MAJOR	NDE	100%	CL 3.6.4 ASME SEC VIII DIV2	NDE REPORT	✓	2	1			
1.7		MECH. PROPERTIES – A.TS B. YS C.% LONGATION D.HARDNESS	MAJOR	MECH	AS PER SB 381 GR F3	MATERIAL GRADE AS PER DRG SB 381 GR F3	IR	✓	2	1			TEST COUPON AS PER 3.10.4.2 ASME SEC VIII DIV2
1.8		VISUAL & DIM. CONFORMITY INCLUDING THICKNESS MEASURT	MAJOR	VISUAL MEASURT.	100%	BHEL DRG.	BHEL DRG. & PO	IR	✓	2	1		
1.9		VERIFICATION OF TCS, IDENTIFICATION & MARKING /STAMPING OF MATERIAL & TEST COUPON AS PER SPECN. & QP	MAJOR	VISUAL	100%	DRG. & QP,	DRG. & QP	IR	✓	2			1

LEGEND: P: - PERFORM, W: - WITNESS, V: - VERIFICATION, INDICATING 1: - BHEL / BHEL NOMMNATED INSPECTION AGENCY, 2: - VENDOR / SUB VENDOR AS APPROPRIATE AGAINST EACH COMPONENT / CHARACTERISTICS UNDER THE COLUMNS P, W & V. *D: RECORDS IDENTIFIED WITH TICK (✓) SHALL BE ESSENTIALLY INCLUDED IN QA DOCUMENTATION.	PREPARED BY:  ALOK BEHERA MGR/ QA	Reviewed by:  B. ASHOK KUMAR AGM/QA	Approved by:  B. ASHOK KUMAR AGM/QA
Format no. : HYQA/QP/VSQP Rev.02			

		BHARAT HEAVY ELECTRICALS LIMITED R.C.PURAM, HYDERABAD	STANDARD QUALITY PLAN FOR VENDOR ITEMS					QP. NO: HYQA/VSQP/2023-24/1032006900/303					
			ITEM: TITANIUM FORGING BHEL SPEC: NA BHEL DRG: as per PO					REV. NO.: 00 DATE: 25.09.2023 PAGE 2 OF 2					
SL NO	COMPONENT/ OPERATIONS	CHARACTERISTICS	CLASS	TYPE OF CHECK	QUANTUM OF CHECK	REF DOCUMENT	ACCEPTANCE NORMS	FORMAT OF RECORD	*D	AGENCY			REMARKS
										P	W	V	
1.10		MATERIAL ATTESTATION BY TPIA	MAJOR	VISUAL	SP	DRG. & QP	DRG. & QP	IR	v	1			

NOTES:

1. TPIA TO CHECK THE LATEST VERSION OF STANDARDS/DRAWINGS /TOLERANCES ETC TO BE MENTIONED IN QUALITY PLAN/DRAWING. THIS QP SHOULD BE READ ALONG WITH BHEL SPEC, BHEL DRAWINGS / APPROVED DRAWINGS, DATA SHEET, BOM AND PO
2. BHEL RESERVES THE RIGHT FOR CONDUCTING REPEAT TEST, IF REQUIRED.
3. BHEL APPROVED INSPECTION ENGINEERS TO BE DEPLOYED FOR INSPECTION.
4. ONLY LEVEL II & ABOVE QUALIFIED PERSON IN RESPECTIVE NDE TO VERIFY OR WITNESS THE NDT TEST REPORT/RESULTS.
5. INSPECTOR TO ENSURE THAT DOCUMENTS (QUALITY PLAN, DRAWINGS, DATA SHEET, PURCHASE SPECIFICATIONS, ETC) ARE AVAILABLE AS PER PURCHASE ORDER BEFORE STARTING THE INSPECTION.
6. TPIA TO REVIEW ONLY THE ORIGINAL TEST CERTIFICATES ISSUED BY THIRD PARTY LABORATORIES OR SUPPLIERS.
7. INSPECTION REPORTS SHALL BE SUBMITTED WITH A REMARK THAT ' COMPARED WITH ORIGINAL TEST CERTIFICATE. REVIEWED, VERIFIED AND FOUND IN ORDER '. TPIA TO ENSURE THE SAME.
8. INSPECTOR TO ENSURE USE OF VALID AND CALIBRATED MEASURING INSTRUMENTS AND EQUIPMENT.
9. TPIA SHALL ENSURE THAT MATERIAL TEST CERTIFICATE & TRACEABILITY RECORDS ARE AVAILABLE FOR USE OF CORRECT MATERIAL.
10. QUALIFICATION OF EQUIPMENT, PROCESS & PERSONNEL FOR SPECIAL PROCESSES LIKE WELDING, BRAZING, PAINTING & METAL COATING ETC.
11. TPIA TO ENDORSE ON ALL CERTIFICATES WITH COMMENTS (WITNESSED OR VERIFIED) AS PER QUALITY PLAN.
12. TPIA SHALL ENSURE THAT LOG SHEETS CONTAIN ACTUAL MEASURED VALUES INSTEAD OF SAYING OK/NOT OK.
13. COMPLETE INSPECTION AND TEST DOCUMENTATION WHICHEVER IS IDENTIFIED WITH (v) UNDER COLUMN D OF APPROVED QULAIITY PLAN SHALL BE ENCLOSED WITH THE INSPECTION REPORT. ALL TEST CERTIFICATES/ REPORTS REVIEWED AND CERTIFIED BY BHEL/TPI SHALL BE SUBMITTED TO BHEL AS DOCUMENTATION PACKAGE
14. ORIGINAL COPIES OF ALL INSPECTION AND TEST DOCUMENTS AUTHENTICATED BY TPIA SHALL BE SUBMITTED.
15. DRAWING / DATA SHEET SHALL PREVAIL OVER QUALITY PLAN IN CASE OF ANY CONTRADICTION BETWEEN QUALITY PLAN AND DRAWING / DATA SHEET.
16. ALL TEST REPORTS SHALL BE PROVIDED AS PER PRESCRIBED FORMATS IN BHEL SPEC.
17. ANY OTHER TESTS/ CHECKS INDICATED IN SPECIFICATION, P.O., OR DRAWING & ANY ADDITIONAL CHECKS ENVISAGED BY BHEL/TPI TO ENSURE WORKMANSHIP, FINISH, AESTHETICS, ETC. SHALL ALSO BE CONDUCTED AND WITNESSED/VERIFIED BY BHEL /TPI / CUSTOMER AS REQUIRED

LEGEND: P: - PERFORM, W: - WITNESS, V: - VERIFICATION, INDICATING 1: - BHEL / BHEL NOMMNATED INSPECTION AGENCY, 2: - VENDOR / SUB VENDOR AS APPROPRIATE AGAINST EACH COMPONENT / CHARACTERISTICS UNDER THE COLUMNS P, W & V. * D: RECORDS IDENTIFIED WITH TICK (✓) SHALL BE ESSENTIALLY INCLUDED IN QA DOCUMENTATION.	PREPARED BY:  ALOK BEHERA MGR/ QA	Reviewed by:  B. ASHOK KUMAR AGM/QA	Approved by:  B. ASHOK KUMAR AGM/QA
	Format no. : HYQA/QP/VSQP Rev.02		

Guidelines for Reverse Auction – 2021

Doc. No. AA:SSP:RA:05

Dated: 08.03.2021

Business Rules for Reverse Auction

Annexure – I

This has reference to tender no **{tender number....date...}**. BHEL shall finalise the Rates for the supply of *{item name}* through Reverse Auction mode. BHEL has made arrangement with M/s. *{Service provider}*, who shall be BHEL's authorized service provider for the same. Bidders should go through the instructions given below and submit acceptance of the same.

The technical & commercial terms are as per (a) BHEL Tender Enq. No. {...} dated {...}, (b) Bidders' technical & commercial bid (in case of two part bid) and (c) subsequent correspondences between BHEL and the bidders, if any.

1. Procedure of Reverse Auctioning

- i. Price bids of all techno-commercially qualified bidders shall be opened.
- ii. **Reverse Auction:** The 'bid decrement' will be decided by BHEL.
- iii. The lowest bidder in sealed envelope price bid shall be shown as current L1 automatically by the system and no acceptance of that price is required. System shall have the provision to indicate this bid as current L1.
- iv. Bidders by offering a minimum bid decrement or the multiples thereof can displace a standing lowest bid and become "L1" and this continues as an iterative process. However, no bidder shall be allowed to lower its bid below the current L1 by more than 5 decrements at one go.
- v. After the completion of the reverse auction, the Closing Price shall be available for further processing.
- vi. Wherever the evaluation is done on total cost basis, after Reverse Auction, prices of individual line items shall be reduced on pro-rata basis.

2. Schedule for reverse auction: The Reverse Auction is tentatively scheduled on *{date}*: *:{start time}*: *:{Close Time}*: *}*.

3. Auction extension time: If a bidder places a bid in the last {...} minutes of closing of the Reverse Auction and if that bid gets accepted, then the auction's duration shall get extended automatically for another {...} minutes,

Guidelines for Reverse Auction – 2021

Doc. No. AA:SSP:RA:05
Dated: 08.03.2021

Business Rules for Reverse Auction

Annexure – I

for the entire auction (i.e. for all the items in the auction), from the time that bid comes in. Please note that the auto-extension will take place only if a bid comes in those last {...} minutes and if that bid gets accepted as the lowest bid. If the bid does not get accepted as the lowest bid, the auto-extension will not take place even if that bid might have come in the last {...} minutes. In case, there is no bid in the last {...} minutes of closing of Reverse Auction, the auction shall get closed automatically without any extension. However, bidders are advised not to wait till the last minute or last few seconds to enter their bid during the auto-extension period to avoid complications related with internet connectivity, network problems, system crash down, power failure, etc.

The above process will continue till completion of Reverse Auction.

Complaints/ Grievances, if any, regarding denial of service or any related issue should be given in writing thru e-mail/ fax to M/s. {Service provider} with a copy to BHEL within 15 minutes prior to initial closing time of Reverse Auction.

4. **Bid price:** The Bidder has to quote the {...} Price inclusive of Packing & Forwarding charges, all the routine & type tests as per tender scope, taxes, duties, freight and insurance as specified in tender document, including loading (if indicated by BHEL due to deviations in technical/ commercial terms) for the Items specified. Details are as shown in Excel Sheet for calculation of total cost to BHEL (To be specified by Unit as per NIT conditions).
5. **Bidding currency and unit of measurement:** Bidding will be conducted in *Indian Rupees per Unit* of the material as per the specifications {...}

In case of foreign currency bids, exchange rate (TT selling rate of State Bank of India) as on scheduled date of tender opening (Part-I bid) shall be considered for conversion in Indian Rupees. If the relevant day happens to be a Bank holiday, then the forex rate as on the previous bank (SBI) working day shall be taken.

6. **Validity of bids:** Price shall be valid for {... days} from the date of reverse auction. These shall not be subjected to any change whatsoever.

Guidelines for Reverse Auction – 2021

Doc. No. AA:SSP:RA:05

Dated: 08.03.2021

Business Rules for Reverse Auction

Annexure – I

-
7. **Lowest bid of a bidder:** In case the bidder submits more than one bid, the lowest bid at the end of Reverse Auction will be considered as the bidder's final offer to execute the work.
 8. Unique user IDs shall be used by bidders during bidding process. All bids made from the Login ID given to the bidders will be deemed to have been made by the bidders/ bidders' company.
 9. **Post auction procedure:** BHEL will proceed with the Lowest Bid in the Reverse Auction for further processing.
 10. Any commercial/ technical loading shall be separately intimated to respective bidders prior to RA. The excel sheet provided in this regard shall cover all these aspects. Commercial/ technical loading if any, shall be added by the respective bidder in its price during Reverse Auction. Modalities of loading & de-loading shall be separately intimated to the bidders. The responsibility for correctness of total cost to BHEL shall lie with the bidders.
 11. Reverse auction shall be conducted by BHEL (through M/s {Service Provider}), on pre-specified date, while the bidders shall be quoting from their own offices/ place of their choice. Internet connectivity shall have to be ensured by bidders themselves.

During the RA process if a bidder is not able to bid and requests for extension of time by FAX/ email/ phone then time extension of additional 15 minutes will be given by the service provider provided such requests come before 5 minutes of auction closing time. However, only one such request per bidder can be entertained.

In order to ward-off contingent situation of connectivity failure bidders are requested to make all the necessary arrangements/ alternatives whatever required so that they are able to circumvent such situation and still be able to participate in the reverse auction successfully. Failure of power or loss of connectivity at the premises of bidders during the Reverse auction cannot be the cause for not participating in the reverse auction. On account of this, the time for the auction cannot be extended and neither BHEL nor M/s. {Service provider} is responsible for such eventualities.

Guidelines for Reverse Auction – 2021

Doc. No. AA:SSP:RA:05

Dated: 08.03.2021

Business Rules for Reverse Auction

Annexure – I

- 12.** Proxy bids: Proxy bidding feature is a pro-bidder feature to safe guard the bidder's interest of any internet failure or to avoid last minute rush. The proxy feature allows bidders to place an automated bid in the system directly in an auction and bid without having to enter a new amount each time a competing bidder submits a new offer. The bid amount that a bidder enters is the minimum that the bidder is willing to offer. Here the software bids on behalf of the bidder. This obviates the need for the bidder participating in the bidding process until the proxy bid amount is decrementally reached by other bidders. When proxy bid amount is reached, the bidder (who has submitted the proxy bid) has an option to start participating in the bidding process.

The proxy amount is the minimum amount that the bidder is willing to offer. During the course of bidding, the bidder cannot delete or change the amount of a proxy bid.

Bids are submitted in decrements (decreasing bid amounts). The application automates proxy bidding by processing proxy bids automatically, according to the decrement that the auction originator originally established when creating the auction, submitting offers to the next bid decrement each time a competing bidder bids, regardless of the fact whether the competing bids are submitted as proxy or standard bids. However, it may please be noted that if a manual bid and proxy bid are submitted at the same instant manual bid will be recognized as the L1 at that instant.

In case of more than one proxy bid, the system shall bid till it crosses the threshold value of 'each lowest proxy bid' and thereafter allow the competition to decide the final L1 price.

Proxy bids are fed into the system directly by the respective bidders. As such this information is privy only to the respective bidder(s).

- 13.** Bidders are advised to get fully trained and clear all their doubts such as refreshing of Screen, quantity being auctioned, tender value being auctioned etc from M/s {Service provider}.
- 14.** M/s. {Service provider}, shall arrange to demonstrate/ train the bidder or bidder's nominated person(s), without any cost to bidders. M/s. {Service provider}, shall also explain the bidders, all the business rules related to the
-

Guidelines for Reverse Auction – 2021

Doc. No. AA:SSP:RA:05

Dated: 08.03.2021

Business Rules for Reverse Auction

Annexure – I

Reverse Auction. Bidders are required to submit their acceptance to the terms/ conditions/ modalities before participating in the Reverse Auction in the process compliance form as enclosed. Without this, the bidder will not be eligible to participate in the event.

15. Successful bidder shall be required to submit the final prices (L1) in prescribed format (Annexure – VI) for price breakup, quoted during the Reverse Auction, duly signed and stamped as token of acceptance without any new condition (other than those already agreed to before start of auction), after the completion of auction to M/s. {Service provider} besides BHEL within two working days of Auction without fail.
16. Any variation between the final bid value and that in the confirmatory signed price breakup document will be considered as tampering the tender process and will invite action by BHEL as per extant guidelines for suspension of business dealings (as available on www.bhel.com).
17. Bidders' bid will be taken as an offer to execute the work/ supplies the item as per enquiry no. {...} dt. {...}. Bids once made by the bidder, cannot be cancelled/ withdrawn and bidder shall be bound to execute the work as mentioned above at bidder's final bid price. Should bidder back out and not execute the contract as per the rates quoted, BHEL shall take action as per extant guidelines for suspension of business dealings (as available on www.bhel.com).
18. Bidders shall be able to view the following on their screen along with the necessary fields during Reverse Auction:
 - a. Leading (Running Lowest) Bid in the Auction (only total price of package)
 - b. Bid Placed by the bidder
 - c. Start Price
 - d. Decrement value
 - e. Rank of their own bid during bidding as well as at the close of auction.
19. BHEL's decision on award of contract shall be final and binding on all the Bidders.
20. BHEL reserves the right to extend, reschedule or cancel the Reverse Auction process at any time, before ordering, without assigning any reason, with

Guidelines for Reverse Auction – 2021

Doc. No. AA:SSP:RA:05
Dated: 08.03.2021

Business Rules for Reverse Auction

Annexure – I

intimation to bidders.

21. BHEL shall not have any liability to bidders for any interruption or delay in access to the site irrespective of the cause. In such cases, the decision of BHEL shall be binding on the bidders.
22. Other terms and conditions shall be as per bidder's techno-commercial offers and other correspondences, if any, till date.
23. If there is any clash between this business document and the FAQ available, if any, in the website of M/s. {*Service provider*}, the terms & conditions given in this business document will supersede the information contained in the FAQs. Any changes made by BHEL/ service provider (due to unforeseen contingencies) after the first posting shall be deemed to have been accepted if the bidder continues to access the portal after that time.
24. Bidder shall not divulge either his Bids or any other exclusive details of BHEL to any other party. If the Bidder or any of his representatives are found to be involved in Price manipulation/ cartel formation of any kind, directly or indirectly by communicating with other bidders, action as per extant BHEL guidelines for suspension of business dealings (as available on www.bhel.com), shall be initiated by BHEL.

Guidelines for Reverse Auction – 2021

Doc. No. AA:SSP:RA:05
Dated: 08.03.2021

Mandate to Service Provider

Annexure – II

Ref :

Date :

To,

M/s. {Service provider}

Sub: Providing of Services for Reverse Auction.

Ref: No {...} date {...}

Dear Sir,

Please conduct Reverse Auction as per the following details:

- **Scope:** Auction event management with training of BHEL and its bidders.
- Seek process compliance form from all the bidders provided by BHEL before start of RA event. In case of postponement of event to some other date, ensure acknowledgement from each bidder.
- Price: Rs. {.....}/- . No other duties, Taxes, levies etc. except service tax @ {.....}% shall be payable for conducting reverse auction. This price is firm.
- Payment Terms: 100% payment after successful completion of Auction.
- Start Price: L1 as per the CST (Comparative statement) of the envelope sealed bid shall be marked as L1 automatically by the system at the start of the auction, provided the L1 bidder participates in the RA by submitting the process compliance form. In case the Process Compliance form is not submitted by the L1 bidder, still its price has to be mapped as start price of RA for further bidding in RA.

Wherever there are more than one L1 in CST, the start price shall be the L1 price reduced by one decrement and the same shall be accepted by the interested bidder(s) for start of RA process.

- Completion of Auction Process: The auction process shall be deemed to have been successfully completed on receipt and acceptance of final report including hard copy/ email of the final bid with price break up, duly signed by the successful bidder who has participated in the reverse auction. The bill shall be submitted along with the completion report to the undersigned.
- Business Rules of the Reverse Auction are as per Annexure – I.
- The list of bidders with their contact details is given in Annexure – IV. and the details of the item (s) to be Reverse Auctioned are as per Annexure – V.
- Please acknowledge receipt of this letter order and also confirm that final report (duly signed and stamped by M/s. {Service provider}) including hard copy/ email of the final bid with breakup of prices duly signed by the successful bidder (duly endorsed by M/s. {Service provider}) shall be submitted within **four** working days of conclusion of auction.

Yours sincerely,

(for and on behalf of BHEL)

Guidelines for Reverse Auction – 2021

Doc. No. AA:SSP:RA:05
Dated: 08.03.2021

Mandate to Service Provider

Annexure – II

Note:

If the event has been conducted as per mandate, you shall be paid irrespective of RA outcome.

Buyer Name	<ul style="list-style-type: none">- Name of BHEL Unit- Full postal address- Fax:- Phone:- Email:- Contact person name:- Phone:-
Auction to be conducted by	<ul style="list-style-type: none">- Name of Service provider- Full postal address- Fax:- Phone:- Email:- Contact person name:- Phone:-
Date of Auction	<ul style="list-style-type: none">- Date of Auction- Reverse auction time:- Auction website:-
Documents Attached: (To be sent to the bidders)	<ol style="list-style-type: none">1) Business rules for Reverse Auction (<u>Annexure-I</u>)2) Process Compliance Form (<u>Annexure-III</u>)3) Details of item (s) to be Reverse Auctioned (<u>Annexure-V</u>)4) Post RA Price confirmation by bidder (<u>Annexure-VI</u>)

Guidelines for Reverse Auction – 2021

Doc. No. AA:SSP:RA:05
Dated: 08.03.2021

Process Compliance Form

Annexure – III

(The bidders are required to print this on their company's letterhead and sign, stamp before RA)

To

- M/s. {Service provider}
- Postal address}

Sub: Agreement to the Process related Terms and Conditions

Dear Sir,

This has reference to the Terms & Conditions for the Reverse Auction mentioned in the RFQ document for {Items} against BHEL enquiry/ RFQ no.{.....} dt. {.....} This letter is to confirm that:

- 1) The undersigned is authorized official/ representative of the company to participate in RA and to sign the related documents.
- 2) We have studied the Reverse Auction guidelines (as available on www.bhel.com), and the Business rules governing the Reverse Auction as mentioned in your letter and confirm our agreement to them.
- 3) We also confirm that we have taken the training on the auction tool and have understood the functionality of the same thoroughly.
- 4) We also confirm that, in case we become L1 bidder, we will FAX/ email the price confirmation & break up of our quoted price as per Annexure - VI within **two** working days (of BHEL) after completion of RA event, besides sending the same by registered post/ courier both to M/s. BHEL and M/s. {Service provider.}

We, hereby confirm that we will honor the Bids placed by us during the auction process.

With regards

Signature with company seal

Name –

Company / Organization

Designation within Company / Organization

Address of Company / Organization

- **Sign this document and FAX/ email it to M/s {Service provider} at {.....} prior to start of the Event.**

Guidelines for Reverse Auction – 2021

Doc. No. AA:SSP:RA:05

Dated: 08.03.2021

List of bidders and their address/ contact person details

Annexure – IV

Sl. No.	Address	Contact Person
1	<ul style="list-style-type: none">- Name of bidder- Full postal address- Fax:- Phone:- Email:	<ul style="list-style-type: none">- Contact person name:- Phone:- Email:
2		
3		
..		
..		

Guidelines for Reverse Auction – 2021

Doc. No. AA:SSP:RA:05
Dated: 08.03.2021

Details of item (s) for Reverse Auction

Annexure – V

1. *{Details of items including quantity, specification, Enquiry no. & date*

- 1.
- 2.
- ..
- ..
- ..
- ..
- }

Guidelines for Reverse Auction – 2021

Doc. No. AA:SSP:RA:05

Dated: 08.03.2021

RA price confirmation and breakup (To be submitted by L1 bidder after completion of RA)

Annexure – VI

To

- M/s. Service provider
- Postal address

CC: M/s BHEL
{Unit-
Address-}

Sub: **Final price quoted during Reverse Auction and price breakup**

Dear Sir,

We confirm that we have quoted.

**Rs. {___ in value & in words _____} for item(s) covered under tender enquiry
No. {...} dt. {...}**

Total price of the items covered under above cited enquiries is inclusive of {Packing & forwarding, GST, E.D., C.S.T., freight and insurance charges up to {.....} District, {.....} State and Type Test Charges etc., (exclusive of service tax), other as per NIT}

as our final landed prices as quoted during the Reverse Auction conducted today {date} which will be valid for a period of {___ in nos. & in words ___} days.

The price break-up is as given below.

Total =====
- Rs. **in value & in words**
=====

Yours sincerely,

For _____

Name:
Company:
Date:
Seal: